



**Asia-Pacific
Economic Cooperation**

Advancing Free Trade
for Asia-Pacific **Prosperity**

Technical Review on Emergency Shelters in APEC Region

APEC Energy Working Group

December 2022



**Asia-Pacific
Economic Cooperation**

Technical Review on Emergency Shelters in APEC Region

APEC Energy Working Group

December 2022

PRODUCED BY



Li Zhu (Prof.)
APEC Sustainable Energy Center (APSEC)
Tianjin University
216 Yifu Building, 92 Weijin Road, Nankai District, Tianjin 300072, China
Tel: +(86)022-2740 0847

Yujiao Huo (PhD)
APEC Sustainable Energy Center (APSEC)
Tianjin University
216 Yifu Building, 92 Weijin Road, Nankai District, Tianjin 300072, China
Tel: +(86)022-2740 0847
Email: apsec2014@126.com

PRODUCED FOR

Asia-Pacific Economic Cooperation Secretariat
35 Heng Mui Keng Terrace
Singapore 119616
Tel: (65) 68919 600
Fax: (65) 68919 690
Email: info@appec.org
Website: www.appec.org

© 2022 APEC Secretariat

APEC#222-RE-01.19

Executive Summary

This literature survey informs APEC forum Energy Working Group (EWG), specifically its sub-forum of Expert Group on New and Renewable Energy Technologies (EGNRET).

The Asia-Pacific region accounts for 52% of the earth's surface area and 59% of the world's population, yet it is subject to more than 70% of the earth's natural disasters. In recent years, natural disasters have been frequent in the Asia-Pacific region. Scientists speculate that the intensity and frequency of disasters in the Asia-Pacific region will continue to increase in the coming decades, exacerbated by unplanned urbanization, poor land-use management, global warming and climate change.

Forward-looking research in emergency response is significant and can go a long way in reducing the losses and hazards caused by disasters. Inadequate power and energy supplies, inadequate resettlement of disaster victims, and unprofessional medical spaces all exacerbate the secondary damage caused by natural disasters. Solar-powered emergency shelters (SPES) can solve all these problems at the same time. The design of a SPES has a clear application scenario, and the focus is not only to meet the "emergency" requirements of accessibility, ease of operation and efficiency but also to ensure an integrated modular design with the solar system. At the same time, it is closely related to the climatic conditions and envelope construction of the affected area, taking into account the health of the inhabitant. This report provides information on the potential applications and technologies related to SPES within Asia-Pacific Economic Cooperation (APEC). Details are as follows:

- **Understanding Needs:** Understand user needs and geographic climate and resource constraints within the APEC disaster management framework.
- **Collection related technologies available:** An overview of research progress in design methods, new materials, novel construction and other technologies related to emergency disaster relief shelters.
- **Theoretical basis:** The theoretical aspects of the main design principles, design influencing factors and key technology systems related to SPES are presented.

- **Broader context:** SPES related exterior available energy supply devices are introduced.

This report begins with a statistical analysis of the types and occurrences of disasters in the APEC region, finding that the most frequent types of disasters are flood, storm, earthquake, landslide and typhoon. The economies with the most disasters are the United States, Japan, the Philippines, Indonesia and China. Subsequently, the latest technologies in various aspects of emergency relief buildings were analyzed, including space and structural design, optimization of enclosure performance and improvement of the physical environment of the interior zone. It was found that the comfort of the indoor physical environment has been given repeated attention. This indicates that humanitarian relief has moved to a higher level. This is followed by an overview of the design elements of solar emergency relief buildings, resulting in a collection of design theories, including the integration of solar technology, modular design, and interior comfort enhancement paths, which could be used to guide the design more systematically. Lastly, an analysis of the winning design competition case with the theme of SPES presents a novel product and concept in terms of modular design, construction process and externally connectable energy systems.

The bulk of the report is an overview of the theory and available technologies related to SPES. There are a number of conceptual shelter designs throughout the APEC economies that incorporate solar energy. This report recommends several other issues for consideration in subsequent studies by the SPES project.

- **Enhancing humanitarian innovation**
- **Assessing the performance of physical products**
- **Open up avenues for multi-scenario applications**
- **Embrace investments and partnerships**

The report concludes that there are significant implications for developing SPES to help struggling communities affected by natural disasters. Renewable energy has the potential to play an important part in lowering carbon emissions, and it also has the opportunity to play an even larger part in responding one of the most significant effects of climate change, which is an increase in the number and severity of natural catastrophes.

The SPES project is able to draw on the latest technology in emergency relief architecture to develop a theoretical basis for its own design and on this basis develop products adapted to APEC, to rebuild communities and improve people's quality of life by providing shelter and energy.

Technical Review on Emergency Shelters in APEC Region
(APEC Project NO.: EWG 01 2022S)

Table of Contents

List of Figures.....	
Project Description and Background.....	
Project Objectives	
Technical Review Aim and Objectives.....	
Chapter 1 Research Background.....	
1.1 Introduction	1
1.2 Natural disaster statistics in APEC	2
1.3 Major climatic conditions in disaster-prone economies.....	4
Chapter 2 Overview of Emergency Shelters.....	
2.1 Definition and characteristics	9
2.2 Spatial and structural design.....	10
2.3 Interface factors	14
2.4 Indoor physical environment	18
Chapter 3 Specific Technology System of Solar-Powered Emergency Shelter	24
3.1 Overall design principles	24
3.2 Main influencing factors.....	26
(1) General Influencing factors	26
(2) Immediacy Influencing factors	27
3.3 Key technology system.....	29
(1) Construction method.....	29
(2) Indoor physical environment optimization	31
(3) Active technology and system integration.....	32
Chapter 4 Demonstration Products of Solar-Powered Emergency Shelter.....	35
4.1 Site information	35
4.2 Manufacturing and assembly process	37
(1) Forms of space.....	38
(2) Component connection	41
(3) Technology integration.....	53
4.3 Available External Devices	62
Chapter 5 Conclusion	

List of Figures

Fig.1.1 Categories of natural disasters in the Asia-Pacific region in the last decade.....	2
Fig.1.2 Distribution of natural disasters suffered by economies in the Asia-Pacific region in the past decade.....	3
Fig.2.1 Proposed modular temporary housing unit design based on standard shipping container dimensions	11
Fig.2.2 Works in exhibition named Crossing: Dialogues for Emergency Architecture.....	13
Fig.2.3 View of the multilayer sample.....	15
Fig.2.4 Studied model geometry.....	16
Fig.2.5 3D-Illustration of the experimental model.....	16
Fig.2.6 Shade net setting method.....	18
Fig.2.7 Temporary shelters in the investigated four districts.....	19
Fig.2.8 The graph of tent structure size diagram	22
Fig.3.1 Temporary shelters six crystalline silicon thin-film photovoltaic modules	32
Fig.4.1 Location analysis	36
Fig.4.2 Climate environment analysis.....	36
Fig.4.3 Post disaster situation	37
Fig.4.4 Shelter Gathering	37
Fig.4.5 Generation of shelter space.....	38
Fig.4.6 Combination mode and life scene.....	39
Fig.4.7 Dimensional drawings of small-scale shelters	39
Fig.4.8 Dimensional drawings of large-scale shelters.....	40
Fig.4.9 Dimensional drawings of two scale buildings	41
Fig.4.10 Building disassembly drawing.....	42
Fig.4.11 Mode and installation position of connecting rod opening and closing part.....	43
Fig.4.12 Polytetrafluoroethylene (PTFE) film	43
Fig.4.13 Cross section of sliding door	44
Fig.4.14 Schematic diagram of sliding door opening and closing mode	44
Fig.4.15 Building disassembly drawing.....	44

Fig.4.16 Exterior envelope panel construction.....	44
Fig.4.17 Floor drain design.....	45
Fig.4.18 Schematic diagram of indoor ventilation.....	45
Fig.4.19 Metal fixed skirting	45
Fig.4.20 Manufacturing of plates.....	46
Fig.4.21 Connection of shelter frame.....	46
Fig.4.22 Shelter frame joints.....	47
Fig.4.23 Shelter accessory parts.....	48
Fig.4.24 Fan and bearing box	49
Fig.4.25 Opening and closing bars.....	50
Fig.4.26 Specific design dimensions and connection methods for opening and closing bars	50
Fig.4.27 Bearing box node.....	51
Fig.4.28 Critical node processing	52
Fig.4.29 Cutting size and paving diagram of PTFE film	53
Fig.4.30 System diagram of shelter energy supply and demand.....	54
Fig.4.31 Indoor wind environment simulation.....	55
Fig.4.32 Flexible thin film photovoltaic paving.....	55
Fig.4.33 Flexible thin film photovoltaic paving: Scheme	56
Fig.4.34 Paving process of flexible thin film photovoltaic	56
Fig.4.35 Test system connection diagram.....	57
Fig.4.36 Power diagram of photovoltaic power generation	59
Fig.4.37 Schematic diagram of photovoltaic series and parallel mode.....	59
Fig.4.38 Dimensional drawing of flexible thin film photovoltaic.....	60
Fig.4.39 Process diagram of photovoltaic series and parallel experiment	60
Fig.4.40 Comparison diagram of solar irradiance and series and parallel power.....	61
Fig.4.41 Series and parallel I-V curve test diagram	62
Fig.4.42 Example diagram of energy station	63

Technical Review on Emergency Shelters in APEC Region (APEC Project NO.: EWG 01 2022S)

Project Description and Background

With just 52% of the world's surface area and 40% of its population, the Asia-Pacific region is home to more than 70% of all natural catastrophes. Over the last decade, they also incurred over USD 100 billion annually in disaster-related losses. Such as Sep. 2018 earthquake in Sulawesi, Indonesia; Nov. 2013 Super Typhoon "Haiyan" hitting the eastern Philippines; the 2012 Super Storm Sandy in the US; May 2008 earthquake in Sichuan province, China etc. Improvements in disaster relief are essential for post-disaster community rebuild.

Energy is in high demand when people are displaced or when the grid fails after a disaster. It is imperative to investigate the current state of technological development of solar powered emergency shelters (SPES) in actual disaster locations, address the difficulties in applying solar technology in disaster relief and discuss possible solutions.

Project Objectives

This project will promote the application and demonstration of a total solution of energy supply and comfortable indoor environment for ERS (Emergency Relief Shelter), based on SPES solution, emphasizing the characteristics of people-oriented, promoting the application of sustainable, high energy efficiency and environmental protection, and responding to APEC's concept about "cooperation, safety, security, efficiency, green technology, and comprehensive development".

This project aims to solve the critical problems faced by disaster victims in the Asia-Pacific region, such as the energy supply and the primary living guarantee. This project will carry out the outcome of SPESS open innovation competition (EWG 22 2015A), and provide an opportunity to explore potential cooperation among APEC economies about establishing a technical guideline for solar emergency shelters in post disaster recovery, especially in susceptible economics to natural disasters.

Technical Review Aims and Objectives

The project collected various cases of solar emergency shelters from different APEC economies. In addition, a technology survey was conducted to review current developments in solar-related energy resilience technologies. Solar-related technologies and products suitable for SPES solutions were reviewed and analyzed from a techno-economic perspective. Attention was given to ways to improve overall energy efficiency and indoor living environments. All findings were summarized in a project report.

Chapter 1 Research Background

Despite accounting for 52% of the Earth's surface area and 59% of the world's population, the Asia-Pacific region suffers from more than 70% of the world's natural catastrophes. The most common catastrophe types are examined in this chapter. Floods, storms, earthquakes, landslides, and typhoons are the five most common disasters, according to the official APEC website. The climatic conditions of the five most affected economies, the United States, Japan, the Philippines, Indonesia and China, were analyzed, taking into account the requirements for the comfort of living in the post-disaster resettlement.

1.1 Introduction

In recent years, natural disasters have occurred frequently in the Asia-Pacific region, and post-disaster response mechanisms and post-disaster resettlement issues have received increasing attention. Forward-looking research in emergency disaster response is significant and can largely reduce the damage and harm caused by disasters.

Most of the existing emergency shelters are traditional temporary military or civilian shelters made of canvas or tarpaulin, with poor insulation and permeability; although temporary panel houses have slightly better insulation, they take longer and require more manpower to set up, and require higher site requirements. According to a survey by scholars, the most intolerable problem in post-disaster temporary resettlement buildings is the hot and stuffy indoor situation. Not only that, secondary disasters brought by the earthquake, such as slippery and muddy ground caused by rain, poor drainage and other issues, also increase the discomfort of the occupants. From the perspective of the comfort of the affected people, the disaster relief shelter is even more lacking in thinking about green ecology and living health. Therefore, not only for humanitarian or social responsibility, the rapid resettlement in the field of emergency relief needs more attention from the society, government and academia.

Solar emergency shelters can simultaneously solve the above-mentioned problems of insufficient power and energy supply, poor resettlement of victims, and unprofessional medical space that exacerbate secondary injuries caused by natural disasters. The integrated modular design and optimization of the indoor physical environment that can be achieved by the combination of photovoltaic technology and emergency shelters not only solves the problems of electricity, transportation and installation, but also minimizes the discomfort of the victims. Considering the spatial characteristics of solar emergency buildings, the modular requirements of assembly, the application of solar technology and the influence of specific climatic condition parameters (solar irradiance, ambient temperature, humidity, wind speed) on the photovoltaic skin and indoor physical environment, the optimal solution should be sought by comparing and quantifying the advantages according to different climatic conditions.

1.2 Natural disaster statistics in APEC

The Asia-Pacific region accounts for 52% of the earth's surface area and 59% of the world's population, yet it is subject to more than 70% of the earth's natural disasters. According to the official website of APEC, floods, storms, earthquakes and landslides occur most frequently among disasters, exceeding 80% of the total number of all natural disasters.

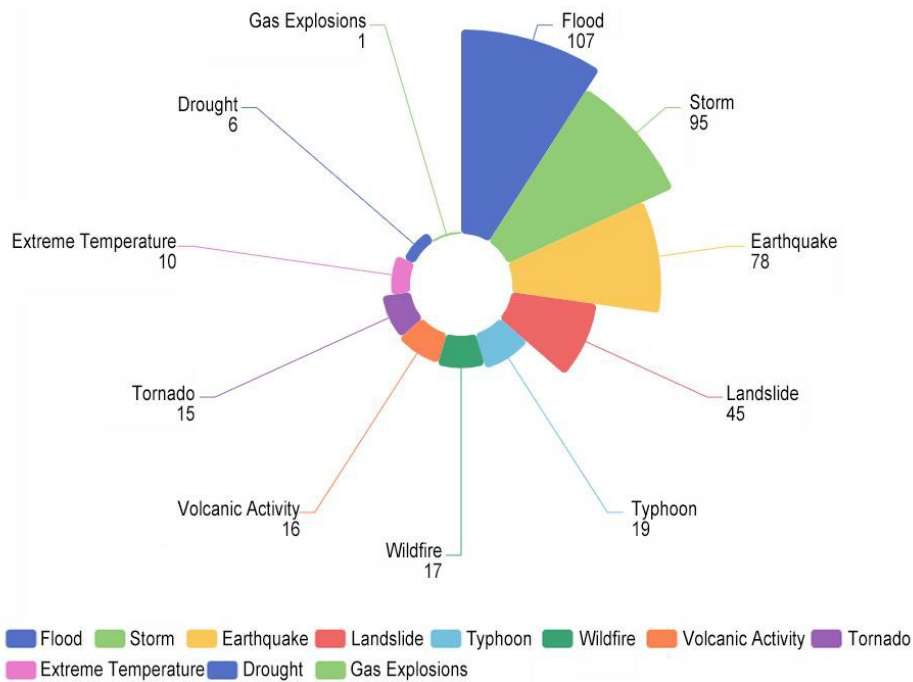

Fig.1.1 Categories of natural disasters in the Asia-Pacific region in the last decade
Data source: <https://www.apec.org/>

Technical Review on Emergency Shelters in APEC Region

According to statistics, among the APEC economies, the US, Japan, the Philippines, Indonesia, China, and Chinese Taipei have suffered more than 20 medium and large natural disasters in the last decade (2010~2020); and Mexico, Viet Nam, Chile, Australia and Korea suffered more than 10, reaching 52% of the statistical total. The December 2004 earthquake and tsunami in Indonesia displaced an estimated 700,000 people and caused massive damage to the local economy, infrastructure and administration. The massive 7.8-magnitude earthquake that struck China's Sichuan province on May 12, 2008 killed more than 87,000 Chinese people and left millions homeless. The massive earthquake and mega-tsunami that struck eastern Japan, on March 11, 2011, hit large coastal areas and caused more than 19,000 casualties and tremendous socioeconomic damage in northeastern Japan. The massive 7.5-magnitude earthquake that struck the Indonesian island of Sulawesi on September 28, 2018 killed more than 2,000 people and caused severe damage to west-central Sulawesi. Scientists speculate that the intensity and frequency of disasters in the Asia-Pacific region will continue to increase in the coming decades, exacerbated by unplanned urbanization, poor land-use management, global warming, and climate change.

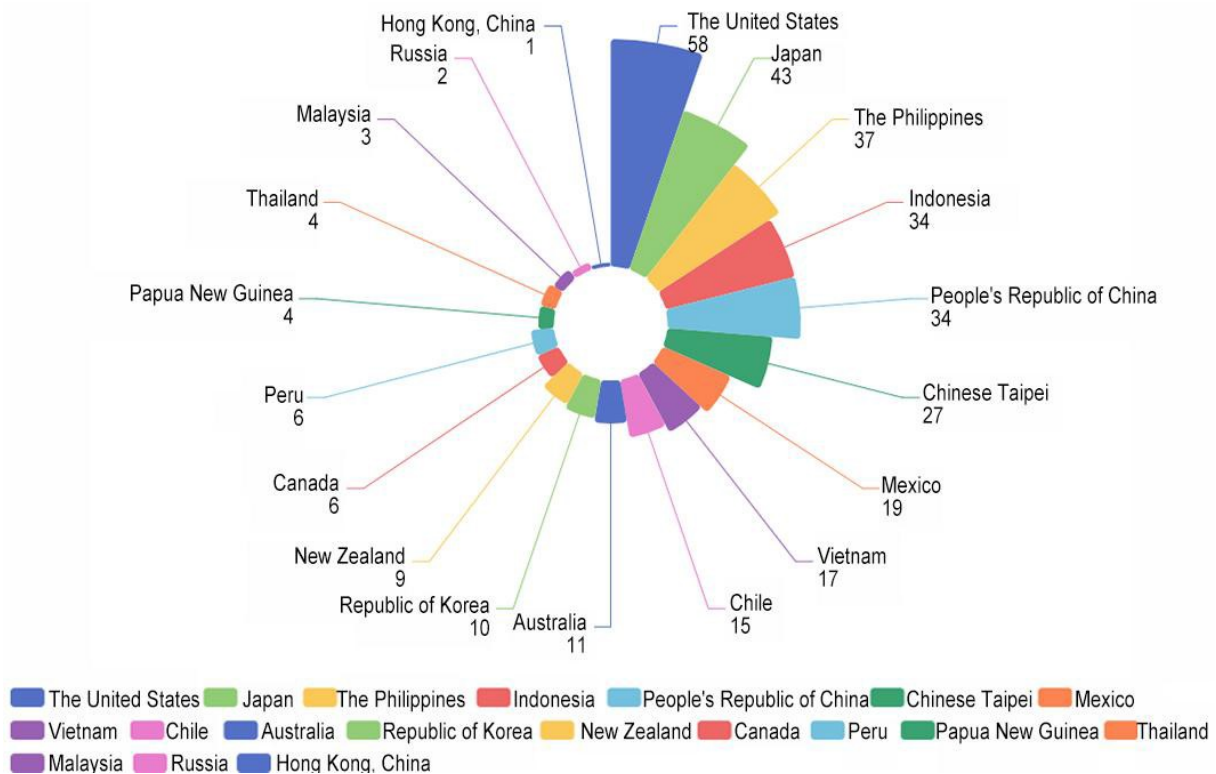

Fig.1.2 Distribution of natural disasters suffered by economies in the Asia-Pacific region in the past decade

Data source: <https://www.apec.org>

1.3 Major climatic conditions in disaster-prone economies

Statistically, the five most severely affected economies are the United States, Japan, the Philippines, Indonesia, and China. China and the United States were severely affected, in large part due to the vast area and complex climatic conditions.

- The climate of the United States varies due to latitude changes and a variety of geographic features such as mountains and deserts¹. On the mainland, the climate of the United States generally becomes warmer as one travels south, and drier as one travels west, until one reaches the West Coast. West of 100°W, much of the United States transitions from a cold semi-arid climate in the interior upper western states (Idaho to the Dakotas) to a warm to hot desert and semi-arid climate in the southwestern United States. Humid continental climate prevails east of 100°W in northern regions (approximately above 40°N, Northern Plains, Midwest, Great Lakes, and New England), changing to a humid temperate climate as one travels east from the Southern Plains and lower Midwest to the Middle Atlantic states (Virginia to southern Connecticut). Many storms that enter the United States originate in the Gulf of Alaska. These so-called "North Pacific lows" come into the land through the Pacific Northwest before moving eastward across the northern Rocky Mountains, northern Great Plains, upper Midwest, Great Lakes, and New England states. "Panhandle hook" storms flow from the central Rockies into the Oklahoma/Texas panhandle regions, then northeast toward the Great Lakes, over the central states from late October to early spring. They produce unusually large temperature contrasts and frequently transport an abundance of Gulf moisture northward. As a result, conditions can occasionally alternate between cold and possibly heavy snow or ice north and west of the storm track and warm and humid with heavy rain and potentially severe thunderstorms south and east of the storm track, frequently simultaneously.
- Japan's climate is primarily temperate, however it differs significantly from north to south². Hokkaido, which is located in the farthest north, experiences a humid continental climate with long, cold winters and warm to cool summers. Although the islands typically have extensive snowbanks in the

¹ https://en.wikipedia.org/wiki/Climate_of_the_United_States

² Karan, Pradyumna Prasad; Gilbreath, Dick (2005). *Japan in the 21st century*. University Press of Kentucky. pp. 18 - 21, 41. ISBN 978-0-8131-2342-4.

winter, the precipitation is rarely very heavy. Winter winds from the northwest bring significant snowfall on Honshu's west coast in the Sea of Japan region. The foehn causes the area to occasionally suffer very high summertime temperatures. The Central Highland experiences significant temperature fluctuations between summer and winter due to its typical inland humid continental climate. The Seto Inland Sea is protected from seasonal winds by the mountains of the Chūgoku and Shikoku areas, which results in moderate weather all year long. Due to the periodic southeast wind, the Pacific coast has a humid subtropical climate with milder winters with sporadic snowfall and hot, humid summers. With balmy winters and sweltering summers, the Ryukyu and Nanpō Islands enjoy a subtropical climate. Particularly during the rainy season, precipitation is particularly heavy. In Okinawa, the major rainy season starts in early May, and the rain front slowly advances north. Typhoons frequently produce significant rain in the late summer and early fall. According to the Environment Ministry, issues have arisen in the agriculture sector as well as other sectors due to excessive rains and rising temperatures. On July 23, 2018, and again on August 17, 2020, scientists in Japan reported a temperature of 41.1°C (106.0°F), the highest ever recorded in the region.

- The climate in the Philippines is tropical maritime, which is typically hot and muggy. There are three seasons: a hot, dry summer (March to May), a wet season (June to November), and a chilly, dry winter (December to February). The northeast monsoon lasts from November to April, while the southwest monsoon lasts from May to October. Typically, temperatures fall between 21°C (70°F) and 32°C (90°F)³. January is the coldest while May is the warmest month. Throughout the year, the temperature is roughly 26.6°C (79.9°F). Latitude and longitude are not important factors when determining temperature because temperatures at sea level typically fall within the same range. Typically, altitude has a greater effect. Baguio is a well-liked vacation resort during the hot summers due to its average annual temperature of 18.3°C (64.9°F) at an elevation of 1,500 meters above sea level. In the rugged east coast region, annual rainfall can reach 5,000 millimeters, although in some of the sheltered valleys, it might be as low as 1,000 millimeters. In a

³Chong, Kee-Chai; Ian R. Smith & Maura S. Lizarondo (1982). "III. The transformation sub-system: cultivation to market size in fishponds". *Economics of the Philippine Milkfish Resource System*. The United Nations University. ISBN 978-92-808-0346-4. Archived from the original on July 19, 2011. Retrieved July 4, 2020.

typical year, about nineteen typhoons hit the Philippine area of responsibility, with eight or nine of those making landfall. This places the island directly in the path of these storms. In Baguio, 2210 millimeters of rain fell between July 14 and July 18, 1911, during the wettest typhoon in Philippine history. The Philippines is one of the top ten economies in the world for climate change vulnerability due to its significant exposure to the effects of the phenomenon.

- Because Indonesia is located near the equator, its weather is typically consistent throughout the year. With no extremes of summer or winter, Indonesia features two seasons: a wet season and a dry season. The dry season for most of Indonesia lasts from May to October, and the wet season lasts from November to April. The tropical rainforest climate that may be found on every significant Indonesian island. In mountainous areas that are 1,300 to 1,500 meters above sea level, more cooling climatic types do exist. In highland regions next to rainforest climates, the oceanic climate (Köppen Cfb) predominates with generally uniform annual precipitation. The subtropical highland climate (Köppen Cwb), which has a more marked dry season, predominates in highland regions close to the tropical monsoon and tropical savanna climates. While some places, like Kalimantan and Sumatra, only see minor variations in temperature and rainfall throughout the year, others, like Nusa Tenggara, see far more dramatic variations, involving floods and droughts throughout the wet and dry seasons. The intensity of rain varies by region, with more falling in the western parts of Sumatra, Java, and the interiors of Kalimantan and Papua, and less in the more arid regions near Australia, like Nusa Tenggara. Temperatures on land are kept fairly steady because to the nearly evenly warm waters that make about 81 percent of Indonesia's surface. Between 70 and 90 percent of the air is humid. Monsoons typically blow in from the south and east from June through October and from the northwest from November through March. Winds are moderate and typically predictable. Mariners are less at risk from typhoons and large-scale storms than they are from rapid currents in passages like the Lombok and Sape straits⁴.
- Northwestern China has a temperate continental climate, the Qinghai-Tibet Plateau has an alpine environment, and eastern China has monsoons

⁴ https://en.wikipedia.org/wiki/Geography_of_Indonesia#Climate

(subtropical, temperate, and tropical). There are tropical, subtropical, warm temperate, medium temperate, cold temperate, and Qinghai-Tibet Plateau regions, according to the division of temperature zones. There are humid zones, semi-humid areas, semi-arid areas, and arid areas based on the distinction of wet and dry areas. Additionally, different wet and dry zones can be found in the same temperature zone, and the same wet and dry zones might contain several temperature zones. As a result, variations in heat intensity and wetness and dryness can be seen within the same climate category. Climate diversity and complexity are complemented by the complexity and diversity of the terrain⁵.

⁵Regional Climate Studies of China edited by Congbin Fu, Zhihong Jiang, Zhaojong Guan, Jinhai He, and Zhongfeng, Xu. Berlin: Springer, 2008. ISBN: 978-3-540-79241-3

Chapter 2 Overview of Emergency Shelters

With the rapid socio-economic and technological development, people are beginning to have the ability to anticipate natural disasters as far in advance as possible through their own efforts to reduce the damage caused by disasters vastly. In addition, out of humanitarian considerations, the World Health Organization (WHO), the International Committee of the Red Cross (ICRC) and the Asia-Pacific Economic Cooperation (APEC) are equally concerned about the rapid resettlement of disaster victims after a disaster. However, due to the less attention received previously and the non-profit nature, there is still a lack of systematic and complete theoretical and practical research on emergency disaster relief architecture, and the practical cases are mostly various design competition proposals and experimental products of some enterprises, which are not put into mass production.

The first UN research on shelter after the disaster was led in 1975 by the newly established United Nations Disaster Relief Organization (UNDRO), a forerunner of the United Nations Office for the Coordination of Humanitarian Affairs (UNOCHA). In 1982, a set of helpful guidelines for helping organizations, such as UN agencies, governments, and NGO's, were produced as a result of a research effort that examined the issues of sheltering after a disaster. The 1982 Shelter After Disaster guidelines were revised and updated in 2015 by the original authors. This revision was made in response to changes that have taken place in the shelter industry and its surrounding environment over the previous 30 years. This chapter will analyze the current development status of solar-powered emergency disaster relief buildings from four aspects combined with existing theoretical studies and practical cases, respectively: definition and characteristics, spatial and structural design, interface performance and indoor physical environment.

2.1 Definition and characteristics

In post-disaster research, the terms "housing" and "sheltering" are frequently used synonymously with minimal distinction⁶. In 1995, Quarantelli proposed the four stages of post-disaster dwelling and distinguished between these concepts. He recommended that the distinction between housing and sheltering post-disaster is made because during sheltering, regular daily activities are put on hold, whereas housing involves the resuming of household responsibilities and activities, such as food preparation, laundry, socializing, work, school, and recreation. The characteristics of the four phases of post-disaster housing are described below⁷.

Emergency sheltering:

Potential victims seeking quarters outside of their own permanent homes for short periods after disaster, disaster victims will accept conditions unacceptable under other circumstances, but emergency medical care facilities is necessary.

Temporary sheltering:

This refers to period that go beyond simply finding shelter during an emergency; it refers to people temporarily relocating to other areas for a short period of time. The crucial point is that home routines need be established unlike emergency sheltering.

Temporary housing:

This entails reestablishing household habits while keeping in mind that permanent housing will eventually be found. There are a lot of topics that don't even have a basic explanation of the tasks and issues, both organizational and domestic, connected with temporary housing. There is some indication that the acceptance of utilizing mobile homes as temporary dwelling varies by social class.

Permanent housing:

Regarding the relationship between temporary and permanent housing, there is a lack of understanding. It has been suggested that the greater community context is

⁶Johnson C. What's the big deal about temporary housing? Planning considerations for temporary accommodation after disasters: example of the 1999 Turkish earthquakes. 2002. TIEMS Disaster Management Conference.

⁷Quarantelli, E. L. Patterns of sheltering and housing in US disasters [J]. Disaster Prevention & Management, 1995, 4 (3) :43-53.

essential to understanding the entire process of finding permanent homes in the wake of a natural disaster.

In 2015, Regan Potangaroa introduced four patterns and phases of interim housing following a natural disaster, namely: spontaneous shelter with "day" as the duration of stay; emergency or temporary shelter with "month" as the period of sheltering; interim housing, where the length of residence is based on "years", and permanent housing, where the duration of residence is based on generations. Comparing the two classifications, the latter one is more applicable to the study of shelter performance⁸. The focus of this study is "emergency shelter", which aims to provide emergency shelter and contact information for organizations that provide food, shelter materials, water, medical care, and essential items. Emergency shelters are no longer limited to simple rest and shelter roles but also require some basic living space separation to meet specific living and privacy needs, such as bedrooms, kitchens, bathrooms and other spaces. At the beginning of the design, the convenience of transportation, erection and disassembly is the primary design and construction criteria, which usually have a relatively single function, living comfort and structural stability of the building is relatively weak, and the possibility of transformation into permanent housing is less and more expensive.

2.2 Spatial and structural design

Three conceptual temporary housing unit design solutions were put forth in 2019 by Omar S. Asfour⁹ based on the Gaza Strip experience, with input from actual displaced individuals and suggestions from regional specialists. Portability, compact area, adaptability, durability, quick assembly, social responsiveness, and environmental responsiveness are the fundamental design principles, and temporary housing unit design is based on standard shipping container dimensions, as shown in Fig.2.1.

Portability: The suggested unit design adopts a shipping container's typical size which allows it to be transported locally, primarily by vehicle delivery. This strategy is centered on recycling old shipping containers and was found to be suitable for the established design criteria. Large amounts of containers can be imported and stored, and it is also feasible to build them locally. Thermal insulation and interior partitioning are two improvements that are necessary.

⁸ Potangaroa Regan. Interim Housing Provision Following Earthquake Disaster[M]. Berlin, Heidelberg:Springer, 2015:1237-1254.

⁹ Omar S. Asfour. Learning from the past: Temporary housing criteria in conflict areas with reference to thermal comfort [J]. International Journal of Disaster Risk Reduction, 2019, 38: 101206.

There are two popular sizes of shipping containers: 20 feet and 40 feet (about 6 and 12m, respectively) and both of which measure roughly 2.4 meters high internally. However, in high-cube style containers, this height rises to roughly 2.65m.

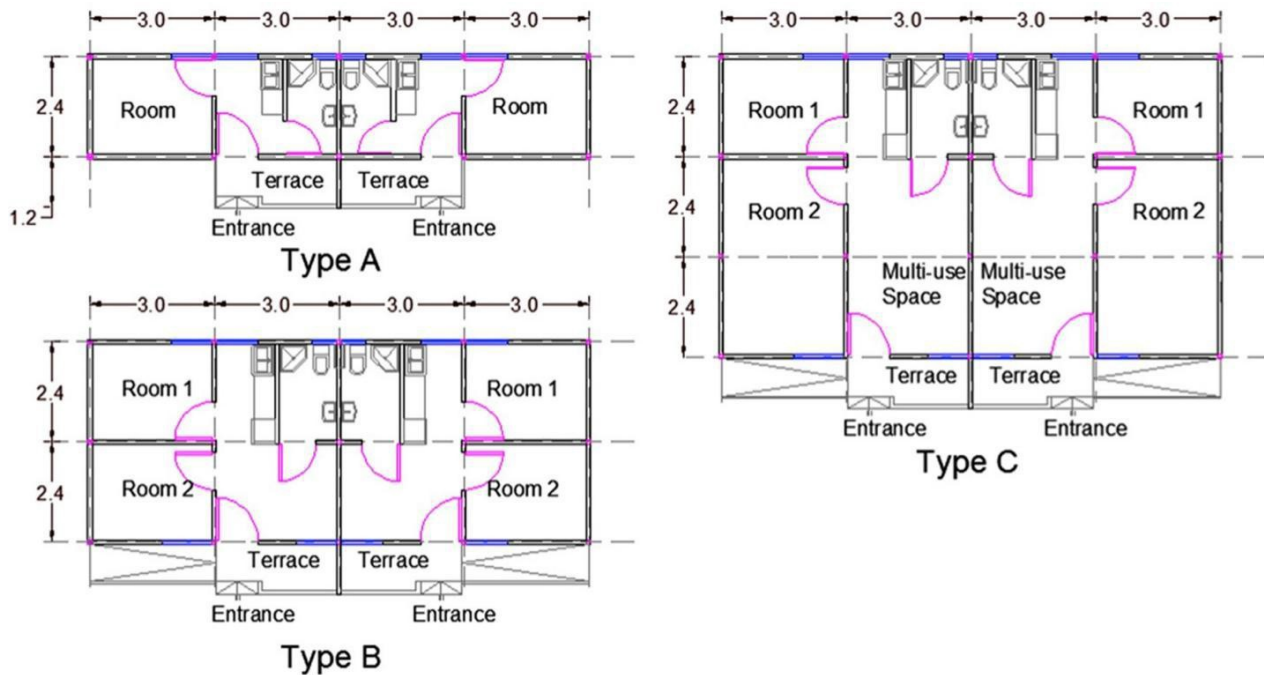

Fig.2.1 Proposed modular temporary housing unit design based on standard shipping container dimensions
 Source: Learning from the past: Temporary housing criteria in conflict areas with reference to thermal comfort

Compact Area: The design strives to meet the basic necessities of displaced individuals. In addition to a bathroom and a kitchenette, each unit has one or more multi-use rooms that can serve as both a living room and a bedroom. In order to accommodate small, moderate, and big family sizes (i.e., 2, 5, and 8, respectively), three sorts of temporary housing units may be helpful, according to the Palestinian Central Bureau of Statistics. The Sphere requirements specify that each occupant of a shelter should have a minimum of 3.5m² of space. This area, excluding cooking facilities, should be supplied in the form of covered living space per person.

Adaptability: The straightforward and modular design makes it easier to link units to meet various family sizes and lowers unit costs. Type A has a kitchenette, a restroom, and one multipurpose area. To supply two semi-attached apartments,

this could be done with one 12m container. Two multipurpose rooms, a compact multipurpose open area, a handicapped-accessible restroom, and a kitchenette make up Type B, which could be accomplished with two 12m containers. Type C is comparable to Type B but has a bigger multi-use open space and an extra multi-use chamber. By employing three 12m containers, this may be realized.

Durability: The shelter should be built of durable materials like steel or wood because of its utilization for a considerable length of time. Steel is supposed to be used for the envelope, and steel with wood could be used for the floor, and windows are assumed to have an aluminium frame. Although steel structures are extremely durable, they nevertheless need sufficient thermal insulation to keep the interior areas comfortable for the occupants.

Quick Assembly: Temporary housing units must be swiftly assembled. As a result, it is crucial to assess the time and labour necessary to produce the required units and implement any design changes. To test this, a pilot unit might be built at a full scale. In what is known as "shelter self-recovery", the labour should be local and could even come from the individuals who are being sheltered. Therefore, it is best to steer clear of complex construction methods.

Social Responsiveness: By including separate bedrooms, independent entrances, and higher windows for each temporary housing unit, the proposed design complies with local social norms. In order to foster a sense of community, it is also possible to group the units to surround a common area for social purposes. Additionally, the construction of the units might be seen as a successful initiative for placing displaced persons in employment.

Environmental Responsiveness: After the emergency scenario has passed, the suggested units could be recycled or utilized again. The proposed design's shallow plan guarantees optimum access to natural daylight and ventilation. Thermal insulation is essential to ensure human comfort, nevertheless.

The main points of structural design were extracted in the exemplar T-Shelters on the Shelter Cluster website. Lateral loads across the building are transferred via a diaphragm structural system to a vertical structure before being directed to the foundations; The bracing between the foundation and the wall above needs to be handled properly. Diagonal bracing in walls that were not located above foundations would lead to unintentionally bending and potentially breaking the bottom wall plates; The gable end needs to be supported on a horizontal structure; The

recommended roof slope is +30, with a single slope roof of 12-14 ° , in order to minimize wind loads¹⁰.

Since Japan is an earthquake- and tsunami-prone economy, there are many studies on emergency disaster response. "Japan's Disaster Response System", written by Gohyo Fuji, Takamine Kato, and Osamu Koide, related to planning, takes the Hanshin earthquake as an example and talks about some functional space design issues in general without doing in-depth research and analysis about the categories and concepts of shelters after a natural disaster¹¹.



Fig.2.2 Works in exhibition named Crossing: Dialogues for Emergency Architecture
 Source: *Creating Architecture of Hope and Happiness— Crossing: Summary of the Dialogues for Emergency Architecture*

To commemorate the first anniversary of the Wenchuan earthquake in China, to draw widespread attention to the reconstruction of the affected areas, and to raise awareness of disaster prevention and mitigation and the protection of life and the environment, the National Art Museum of China invited 16 internationally renowned teams of outstanding architectural designers to participate in an exhibition of 16 emergency buildings designed for typical natural or social disasters in different

¹⁰ R Potangaroa. Interim Housing Provision Following Earthquake Disaster[J]. Springer Berlin Heidelberg, 2015.

¹¹ Gohyo Fuji. Japan's Disaster Response System[M]. Beijing, China Architecture Publishing & Media Co., Ltd., 2003

regions and climates around the world from May 12 to 24, 2009¹². The essence of emergency shelter is an extreme form of architecture, which Pablo Castro and Jennifer Lee of OBRA Architects perceptively describe as "architecture on the edge of survival". By its extreme character, emergency shelter is not only at the edge of survival but also at the edge of the architectural field. Half of the participating architects in this exhibition are not specialized in emergency architecture but are instead known for their innovation and creativity in the field of "high-end design". Rintala Eggertsson Architects proposes to assemble several small independent units into a fully functional building. Each unit contains a specific function, such as sleeping, cooking, hygiene, washing and storage. Different combinations of these units allow the overall structure to be adapted to different external conditions such as climate and topography, as well as internal conditions like social and cultural requirements¹³.

Jinyang Chen et al. studied most of the simple disassembly camping shelters on the market by understanding the main mechanical structure, drafting an optimized mechanical structure, and applying modelling analysis to determine the final solution so that the mechanical structure can achieve rapid installation and disassembly¹⁴. A foldable lightweight structural system researched by scholars at the Chinese University of Hong Kong has built the MCEDO school, which can accommodate approximately 600 slum children for learning and recreation, in just thirty days in Kenya, nine thousand kilometers away.

2.3 Interface factors

Interface factors include all interfaces that affect the shelter's internal environment, including the shelter's envelope and shading around the shelter, etc. An insulator with multiple layers that can give users of a new shelter enhanced thermal comfort. Thermal properties that were obtained experimentally using a guard ring device at various working temperatures were explored by Graziano Salvalai et al. in 2015. The core of a novel lightweight emergency architecture, a composite structure comprised of the multi-layer insulator and two air gaps coated in a polyester cover, is tested as well as the multi-layer insulator itself. The thermal conductivity and transmittance of the tested multi-layer, as determined by experimental results, are around 0.04 W/(m °C) and 1.6 W/(m² °C), in good accord with published data. With a thermal transmittance of

¹²Editorial Board of the Journal. For the Memorial of "May 12"—Crossing: Dialogues for Emergency Architecture[J]. Chinese Art Digest, 2009, 4: 66-67.

¹³Pan Qing. Creating Architecture of Hope and Happiness— Crossing: Summary of the Dialogues for Emergency Architecture[J]. Decoration, 2009, 7: 46-51.

¹⁴Chen JY, Xu YY, Pan RW. Design of the Mechanism of Retraction for the Tent[J]. China Southern Agricultural Machinery, 2019, 050(003): 126-127.

0.85 W/(m² °C), the composite structure defined as Thermo Reflective Multi-layer System (TRMS) exhibits improved insulation abilities. The thermal performance of an emergency shelter based on the new insulating structure (TRMS) has been compared to that of a traditional emergency shelter provided by the UNHCR. Based on the environment in Belgrade and just using the incidental gains from occupants and solar radiation via opaque walls, the shelter model was simulated throughout the winter. The new insulating composite envelope reduces the necessary heating load between two and four times compared to the previous insulation, according to numerical simulations. The research serves as a foundation for the development of a lightweight emergency architecture consisting of multi-layer, air, polyester, and vulcanized rubber (Fig. 2.3)¹⁵.

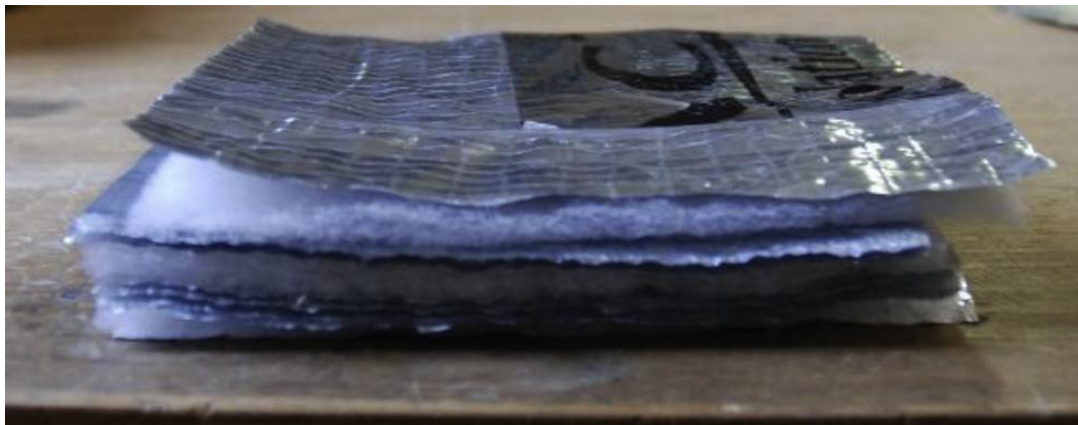

Fig.2.3 View of the multilayer sample

Source: Thermal performance measurement and application of a multilayer insulator for emergency architecture

Due to their lack of adequate thermal mass in their envelope, lightweight shelters that can be moved, transported or built off-site frequently experience dramatic changes in indoor temperature during the heating and cooling seasons. This causes them to use a lot of energy to maintain a comfortable indoor temperature. Applying phase change materials (PCM) is thought to be a potential way to regulate the temperature inside lightweight structures. The numerical data published by Paula Marin et al. (2016) demonstrated the potential for energy consumption reduction, in arid and warm temperate climate areas, due to the incorporation of PCM in the gypsum board used in lightweight building envelopes both for heating and cooling periods. On the other hand, tropical and snowy regions have very little opportunity for energy savings. The Gypsum board used in the envelopes had a PCM integrated into it that had a melting point of 25°C, allowing for significant energy savings for heating and cooling in a variety of climates.

¹⁵AGS, AMI, BDS, et al. Thermal performance measurement and application of a multilayer insulator for emergency architecture[J]. Applied Thermal Engineering, 2015, 82:110-119.

Additionally, it was discovered that the PCM utilized in specific cities should have been chosen with a lower or higher melting point and thus concentrated its heating or cooling reduction efficiency, respectively. In this context, the authors identify the optimization of the PCM melting temperature based on the meteorological conditions as a future work that could exploit the potential and open it up to having benefits in regions where they were not achieved with the studied PCM (25°C), such as tropical and snowy main climate areas. When employed on highly lightweight buildings, like emergency shelters, the impact of PCM is maximized¹⁶.

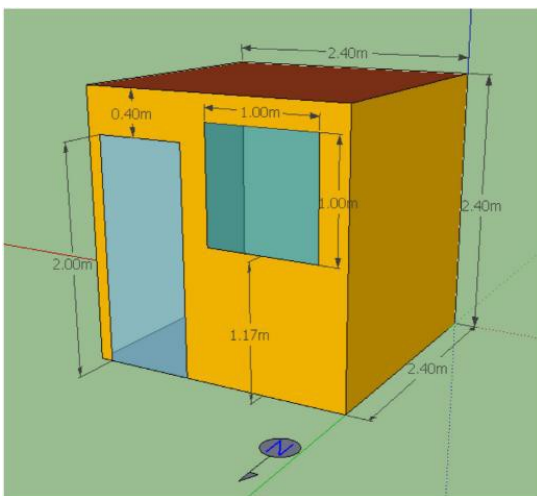

Fig. 2.4 Studied model geometry

Source: Energy savings due to the use of PCM for relocatable lightweight buildings passive heating and cooling in different weather conditions

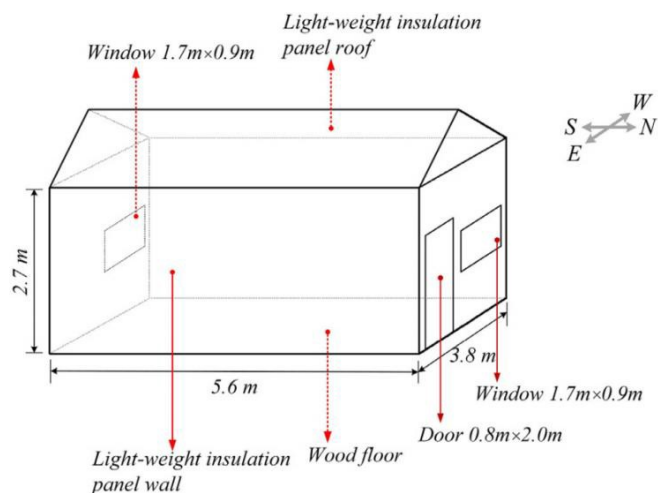

Fig. 2.5 3D-Illustration of the experimental model

Source: An experimental study on applying PCMs to disaster-relief prefabricated temporary houses for improving internal thermal environment in summer

Caixia Wang et al. (2018) conducted an experimental study of applying PCMs with two different designs to prefabricated temporary houses (PTH), and a 3D-Illustration of the experimental model was shown in Fig.2.5. In Design case 1, PCMs were attached to a model PTH’s internal surfaces, and the associated experimental findings showed that both the indoor air temperature and the internal surface temperature of the prototype PTH could be lowered during the day. However, in Design case 2, a mobile PCM based energy storage system (PESS) was employed, and the associated experimental findings indicated that the use of the mobile PESS with a total charge of 148.8kg PCM helped lower the average indoor air temperature by 3.2-3.6°C. The experimental findings from both models revealed that a mobile PESS system was chosen because it could be moved outside at night to be charged with more cooling energy using colder outdoor air without

¹⁶PaulaM, MohammadS, AlvarodeG, et al. Energy savings due to the use of PCM for relocatable lightweight buildings passive heating and cooling in different weather conditions[J]. Energy and Buildings, 2016, 129: 274-283.

negatively impacting the air temperature within PTHs. It is because disaster relief is a mobile endeavour, and since outdoor air at a lower temperature may be the only source of cooling energy for charging the PCM¹⁷.

Solar heat reflective coatings can change the thermal radiation characteristics of the coated object itself or adapt its overall thermal radiation characteristics to the surrounding background. In addition, solar heat reflective coatings reduce the temperature of the coated object and prolong the service life of the film by decreasing the thermal ageing effect of the coating in sunlight. At present, most of the studies on heat-reflective coatings for buildings have been conducted, but fewer studies on heat-reflective coatings for shelters. Yang et al. (2008) proposed a kind of green heat-reflective coating which is made by using the selected emulsion as the film-forming substance and adding modified hollow glass beads, nano-silica, titanium dioxide and other reflective substances, which has good water resistance and weather resistance and is an environmentally friendly coating that is not harmful to human health. The coating has a good reflective cooling ability and can effectively reduce the shelter roof and interior temperature by 10-12°C and 6-8°C, respectively, and has a heat preservation effect when used at low temperature, furthermore provide a more comfortable working and living environment for the users¹⁸.

Shade netting is another available form of interface for shelter to effectively block solar radiation. Liu Jingbo et al. (2016) tested and analyzed the internal thermal environment of a shelter by setting up a black shade net on the tent. The "three-needle shade net" and "six-needle shade net", which have good shade evaluation and are widely used, were selected for the experiment. The shading net with six-needle fabric density has a shading rate of 96% or more, with a good shading effect, but the fabric density is large, which is not favourable for the replacement of hot air circulation under the net; the three-needle shading net has a shading rate of about 75%, but the hot air circulation under the net is good. The experimental object is 93 types of military cotton tent: 4.4m (long) × 4.6m (wide), 2.57m high at the top and 1.4m high at the sides, and the shading net is erected to the top at the height of about 1m (Fig. 2.6). Data showed that the tent needs to strengthen the shading on the east and west sides. The shading net erected on the top can block the sunlight and prevent direct sunlight from reaching the top of the tent, but the shading effect on the east and west sides is limited. It is suggested that additional shading nets need to be set up on the east and west sides to reduce the radiation; in the north, the top shading nets be moved south

¹⁷Caixia Wang, Xiao Huang, Shiming Deng, et al. An experimental study on applying PCMs to disaster-relief prefabricated temporary houses for improving internal thermal environment in summer[J]. *Energy and Buildings*, 2018, 179: 301-310.

¹⁸Yang Wanguo, Li Shaoxiang, Wang Wenfang, et al. Research on Army Green Heat Reflective Coatings for Tents[J]. *Paints & Coating Industry*, 2008 (9) : 22-24

appropriately to reduce the radiation on the south sides¹⁹.



Fig. 2.6 Shade net setting method

Source: Experiment Research on Shading to Improve the Thermal Environment of Tents

2.4 Indoor physical environment

When there is a natural disaster, shelters such as temporary prefabricated houses (PHs) are beneficial in providing disaster victims with a temporary living space rapidly. An experimental investigation of the indoor thermal conditions in a subtropical PH was conducted by Yan Wang et al. (2016). According to the findings, the air temperature inside the experimental PH was quite high during the summer days but very low during the winter nights when the doors and windows were closed. Additionally, during summer days, the variation in air temperature inside the PH appeared to follow the change in outdoor air temperature, which indicated that the envelope's thermal mass was insufficient to store solar heat gain. Stratification of the temperature inside structures was also observed in both the winter and the summer. The temperature inside structures increased during the day but fell during the night as a function of height. Last but not least, in both winter and summer, exterior roof temperatures were lower than the ambient air temperature, showing the cooling effects of the sky on the test PH. The assessed indoor thermal conditions made it abundantly evident that they are completely unsuitable for long-term habitation and that the proper measures should be taken to enhance them in PHs²⁰.

¹⁹LiuJingbo, JiangYingni, HuXinbu, et al. Experiment Research on Shading to Improve the Thermal Environment of Tents[J]. Power Generation & Air Condition, 2016(1): 87-94.

²⁰Wang, Y., Wang, L., Long, E., & Deng, S. (2016). An experimental study on the indoor thermal environment in



Fig. 2.7 Temporary shelters in the investigated four districts. (a) Lalitpur, (b) Kathmandu, (c) Shindhupalchowk and (d) Gorkha.

Source: Field study on acceptable indoor temperature in temporary shelters built in Nepal after massive earthquake 2015

Lalitpur, one of the earthquake-affected districts, was used for the field measurement of the indoor thermal environment in five shelters. The average nighttime indoor and outdoor air temperatures were found to be 10.3°C and 7.6°C, respectively. The nocturnal inside air temperature stayed below the minimum allowable value of 11°C. This outcome confirmed that these shelters are unsuitable for the winter and, therefore, must produce a number of issues. In order to find a potential improvement, Rita Thapa (2019) thus examined the thermal properties of those shelters based on the measured results. In five shelters, the calculated total heat loss coefficient per square

prefabricated houses in the subtropics. Energy and Buildings, 127, 529 - 539.

meter ranged from 11.3 to 15.2W/(m²K), indicating very little thermal insulation. With the assumption of improved thermal characteristics, a straightforward numerical analysis was performed on the variation of indoor air temperature and discovered that it requires a reduction of about 2-7W/(m²K) in order to maintain an indoor air temperature higher than 11°C for 70% of the entire nocturnal period. The addition of inexpensive materials, such as cellular polyethylene foam and clothing for the appropriate walls and roof, was determined to be the key to achieving this reduction in heat loss²¹. This same researcher conducted a series of surveys on the indoor thermal environment and thermal comfort in four major earthquake-affected districts (Lalitpur; Kathmandu; Sindhupalchowk; Gorkha) in order to understand the seasonal changes of the interior temperature and determine the appropriate range of temperature experienced by people living in varied temporary shelters that were mostly self-built after the massive earthquake. Temporary shelters in the investigated four districts are shown in Fig. 2.7.

With 1407 samples, the survey was carried out during the three seasons of fall, winter, and summer. The seasonal difference is 20.1°C, with the mean interior globe temperature varying between 12.1 and 18.5°C in winter and 26.9 and 33.2°C in summer. Making it warmer in the winter and cooler in the summer was preferred by respondents by a large margin. The four districts' mean comfort temperatures ranged from 15.0°C to 28.6°C, with a seasonal difference of 13.6°C between the two. It was discovered that the range of indoor globe temperatures that 80% of the respondents would be tolerated was between 11°C to 30°C. The permissible range could be used as a guide when creating thermally acceptable shelters to be ready for an impending calamity²².

The evaporation of the water mass is able to take away a lot of heat, and the combination of the water and the envelope is a suitable technology to improve the indoor thermal environment in hot summer and warm winter areas. The experiment was conducted on a tent with a weight of 37.4kg that can accommodate six people with a length, width, facade height and top height of 4m, 3m, 1.2m and 1.95m, respectively. Its east and west have a square vent (0.55m × 0.55m) with 0.8m high from the ground, and the center of the south facade has an entrance and exit (1.2m × 1.5m). Experimental data show that the tent envelope structure is a waterproof canvas with a layer of aluminium foil inside. In the absence of solar radiation, the temperature of the top of the tent and the temperature inside the tent are basically the same, while with solar radiation, the temperature of the top of the tent is obviously higher than the internal air temperature. In the case of drenching,

²¹Thapa R, Rijal HB, Shukuya M, et al. Study on the wintry thermal improvement of makeshift shelters built after Nepal earthquake 2015 [J]. *Energy and Buildings*, 2019, 199:62-71.

²²Thapa R, Rijal HB, Shukuya M. Field study on acceptable indoor temperature in temporary shelters built in Nepal after massive earthquake 2015 [J]. *Building and Environment*, 2018, 135:330-343.

the temperature at the top of the tent changed evidently. After the drenching started, the temperature of the inner surface of the tent decreased gradually, and after the drenching stopped, the temperature gradually increased and then decreased in the next drenching process, and repeatedly. The temperature of the inner surface of the tent was changing in a sawtooth shape, and the maximum temperature drop at two adjacent points could reach 19.75°C ²³.

The research on improving the indoor physical environment of the tent in Chongqing, China, showed that compared with a single tent, the use of the three-layer structure of enclosure could greatly improve the heat insulation performance; the skylight can make use of thermal pressure to discharge the hot air inside the tent, which can obviously reduce the air temperature inside the tent in summer; The double top structure can effectively reduce the internal temperature of the tent and the surface temperature inside the top in summer, thus increasing the comfort of the living environment. In terms of wind resistance, when the gap between the double tops is less than 0.4m, the vertical and horizontal forces caused by wind pressure in the tent do not change much. On winter night, when a 1000W heat source exists inside the tent, the internal temperature of the heated tent is 6.1°C higher than that of the unheated one, which greatly increases the thermal comfort²⁴.

A comparison was made between the thermal insulation tent and the cattle-hair tent in the plateau climate of China. The canopy thickness of the insulation tent is 3mm, and it is composed of three layers of fabric: the fabric is sky blue polyester fabric with PVC coating, the interlayer is needled cotton, and the inner material is white polyester fabric. The tent is made of two pieces of black yak hair fabric stretched and pulled. The test data showed that the thermal conductivity of the thermal insulation tent is smaller than that of the cow-hair tent, and the thermal insulation tent has significant advantages in coping with the cold weather of rain and snow. The air permeability and vent design of the cow-hair tent are better than that of the thermal insulation tent, and its heat dissipation performance is better. For the thermal insulation tent itself, the ventilation and heat removal effect of the skylight is better than that of the side window²⁵.

In the hot summer climate of Chengdu, China, the tent adopts a phase change material that can effectively control the indoor air temperature fluctuation and reduce the maximum indoor temperature by 6.4°C , but it will lead to higher indoor temperature than the outdoor temperature at

²³ Hu Shaohua, Meng Qinglin, Wang Chaomin. Experimental Research of improvement on thermal environment of tents' by passive cooling[J]. Journal of Logistical Engineering University, 2007 (2): 81-87

²⁴ Tao Wang. Research on Indoor Thermal and Humidity Environment and Simulation of Improvement Measures for Relief Tents [D]. Chongqing: Chongqing University, 2009.

²⁵ Luhong Huang, Ying Hong, Enshen Long. Study on Improvement of Highland Climate Adaptation of Civil Relief Tents[J]. Building Science, 2013, 29(12): 50-54.

night. Also, the natural ventilation at night can take away the heat stored in the phase change material during the daytime, which could reduce the indoor air temperature by 2.5°C at most²⁶. Some data indicated that a reasonable design index for tents in the area is between 0.8% to 3% for skylight area ratio and between 5% to 15% for side window area ratio²⁷.

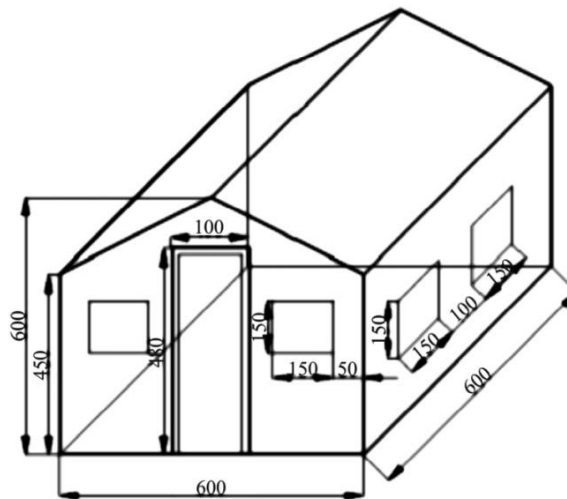

Fig. 2.8 The graph of tent structure size diagram

Source: *Natural Temperature Control Materials Energy Saver and Natural Ventilation in Night to Improve the Tent Thermal Environment*

Data from experimental measurements of the light-colored tent with a double slope roof revealed that the average temperature was lower and the cooling effect was more pronounced in the tent with coating than in the tent without coating. The average temperature data from each sensor in the coated tent show that it cools more effectively during periods of high temperatures and intense sunlight exposure than the uncoated tent does. The temperature inside the coated tent is also lower than the ambient temperature during the noon and afternoon time periods. Furthermore, future tent coating research and development will focus on composite thermal insulation coating with good performance, while environment-friendly and solvent-free thermal insulation coating will also become a future trend in tent thermal insulation application²⁸.

In cold areas of China, the use of natural ventilation has a positive effect on regulating the thermal

²⁶Yinfu Bai, Long Xu, Xinyu Liao, et al. Natural Temperature Control Materials Energy Saver and Natural Ventilation in Night to Improve the Tent Thermal Environment [J]. Refrigeration and Air Conditioning (Sichuan). 2014 (5) : 556-559.

²⁷Xi Meng, Suo Wang, Yanru Li, et al. Experimental Research on Optimization of Window Surfaces in Tents [J]. Building Technology Development, 2016, 43 (4) : 19-21.

²⁸Feng Tian, Mingxi Hu, Aijuan Ni, et al. Experimental study on thermal insulation effect of insulation coatings of emergency treatment tent [J]. Chinese Medical Equipment Journal, 2017, 38 (9) : 12-15.

environment inside the tent. In the transitional season, the use of skylights has a significant effect on the control of temperature inside the tent²⁹. During the transition season, the indoor thermal environment of the tent is poor. Natural ventilation reduces the indoor air temperature and surface temperature, the two most important factors affecting the indoor thermal environment of the tent. However, only by taking natural ventilation improvement measures, the indoor thermal environment of the tent still exceeds the comfort range of CET (23-26°C). In the later stage of tent erection, the tent layout and orientation should be focused on as much as possible to increase the indoor wind speed to reduce the tent's indoor temperature and surface temperature and enhance the convective heat exchange and evaporative heat dissipation^{30 31}.

²⁹Gong Zhengguo, Jiang Yingni, Liu Jingbo, et al. Study on Influence of Natural Ventilation Exercises on the Thermal Environment of Single Tents during Transitional Season[J]. Power Generation and Air Conditioning, 2017(1): 86-89

³⁰Erqing Zhao. ANALYSIS OF THE EFFECT OF NATURAL VENTILATION ON THE INDOOR THERMAL ENVIRONMENT OF THE TENT DURING THE TRANSITIONAL SEASON[J]. LOW TEMPERATURE ARCHITECTURE TECHNOLOGY, 2018(7): 143-145.

³¹Erqing Zhao. Study on thermal environment and improvement measures of the military tents [D]. Xi' an: Xi' an Polytechnic University, 2016.

Chapter 3 Specific Technology System of Solar-Powered Emergency Shelter

This chapter primarily explains the general design tenets, significant influencing variables, and critical technological systems of solar-powered emergency shelters. The term "emergency" remains the key component of solar emergency shelters. This indicates that the first element that has to be taken into account during design is "immediacy". Easy to understand, easy to operate and efficient are the main design level affecting elements. Construction methods, interior environment optimization, active technology, and system integration as important technological systems were introduced. The permeability is slightly subpar since emergency rooms or tents are frequently built on the ground in disaster zones. The enhancement of the indoor environment through technology is crucial because the evaporation of water vapour from the surface results in high inside air humidity, which further affects the comfort of human habitation.

3.1 Overall design principles

Architecture is a product of the integration of art and technology, and a solar-powered emergency disaster shelter brings these two core elements to the forefront on a smaller scale, not only in terms of aesthetics, ease of construction, and functional applicability, but also the utilization of green, clean energy and active-passive technologies. Attaching these considerations to a small shelter is a test of the designer's ability to make trade-offs between design factors.

At the level of green and health, although there are already complete green and health design standards, for the special field of emergency and disaster relief buildings, the basis of design, the main influencing factors, and the whole life cycle operation mode are different. Therefore, the previous green and health-relevant design standards cannot be directly used as design and

testing criteria, but can only be partly referred to, extracted available factors from them, and re-summarized according to the characteristics of emergency and disaster relief buildings themselves.

At the level of functional structure, as a building to solve the problem of disaster relief in the shortest possible time, "timeliness" is always the primary factor in the design of emergency relief buildings, and a series of design points brought by timeliness, such as the convenience of building transportation, easy to understand and operate the structure, and the efficiency of construction are all issues that cannot be ignored. The lack of each link will cause a major loss of timeliness. The structure of the building itself should also have an assembled modular design, which is convenient for mass production and the individual replacement of building components at a later stage, and through the simple modification and replacement of materials and structural modules to achieve the adaptability to different site requirements and climate conditions, modular splicing also provides more possibilities for the expansion and transformation of the building functions afterwards.

At the technology selection level, a combination of active and passive technologies should be employed, with "humanism" as the basic design focus, to bring a better comfortable environment to the users with minimal cost. Reducing the energy demand of shelters through rational design of the envelope. Since large-scale power outages are often caused by major natural disasters, areas need to restore the power system in a timely manner, and common post-disaster power generation measures include emergency power generators/generators (sets) and the use of traditional fossil fuels (e.g., fuel oil)³². However, due to the number of generator sets and transportation pressure, there is mostly a shortage of power supply, which is not conducive to quickly helping people in disaster areas to survive the post-disaster resettlement period³³. With the continuous maturation of photovoltaic technology, the combination with buildings has become increasingly close in recent years. Solar emergency shelters, as a new type of emergency disaster relief buildings, have stronger environmental adaptability and great development potential.

By comparing the green and healthy design standards of different economies and analyzing the research of scholars on emergency and disaster relief buildings, and combining various necessary considerations of solar emergency shelters, solar emergency shelters should include passive design, active design and design-build processes.

³²Xinyi Jiang, JianChen, KailunSi, et al. Emergency Response Strategy of Integrated Energy Distribution Network Considering Dynamic Transportation Network[J]. Smart Power, 2020(322):31-37.

³³JunfengLi, XiaoliLiu, JiLi, et al. Contradictions and problems facing the post-disaster energy supply[J]. China Investment, 2008(003):54-57.

3.2 Main influencing factors

(1) General Influencing factors

With reference to the existing academic and practical achievements, we conduct an in-depth analysis of the relevant elements of emergency disaster relief architectural design research, summarize and conclude the architectural design principles according to the requirements of different attributes of buildings in different environments, and finally refine the general influencing factors for the design level, which are easy to understand, easy to operate and efficient.

- Easy to understand mainly refers to the building in the process of building, the structural components of the building, the building process and the division of the building use and functional settings. On the one hand, there should be clear operation manuals and on-site guidance from professionals, and on the other hand, the spatial structure and functional partition of the building should be clearly divided. We try to simplify the structural components and building steps to avoid mistakes due to improper operation during the building construction process.
- Ease of operation requires the design to avoid overly complex spatial structures and components and to use as many common connection components and construction tools as possible in the market. The use of the same specification of connecting parts reduces the mix of different tools; even without tools, only the use of a bayonet connection or folding ready-to-use design and construction method reduces the delay in the installation on site. When the affected people first get the shelter parts, they only need a small amount of time to learn the skills and complete the correct installation and arrangement of the whole shelter.
- Efficient means that the shelter should be settled quickly and in the shortest possible time so that it can be used to its fullest potential. If the best time is missed, both the disaster relief and the resettlement of the victims will lose their original role and meaning. "Efficiency" is the most important factor affecting the success or failure of the shelter design. Rapid transportation to the disaster site, effective resettlement and relief work, and maximum satisfaction of the disaster victims' needs for

emergency shelter are the core of the design.

(2) Immediacy Influencing factors

The most important feature of solar emergency shelters is still the word "emergency", which means that "immediacy" is the first factor that should be put into the design. Otherwise, nothing can be done. After a natural disaster, when everything around is destroyed, and materials are most scarce, the emergency shelter starts to play its value. The key to the design is to use the shortest time and rely on the fastest speed in complex situations, small groups or individuals independently, to complete the construction of simple shelters so that the victims have a temporary shelter while providing space for the injured people to heal and recuperate. Not only to survive but also to stabilize the victims' emotions and strengthen their will to live.

The type of local natural disasters occurring, the local climatic environment and natural landforms, etc., are used as the basis for design, and the construction level insists on the premise that the building is easy to transport and quickly erected while ensuring residential comfort and energy conservation and environmental protection, so the choice of materials is also a reflection of the originality and integrity of the overall design, while the design for different sites requires shelters with strong versatility and applicability.

- The transportation method is a link that cannot be ignored in the rapid response, directly determining whether it can be quickly transported to the disaster area and play a real role in emergency resettlement. In order to transport more relief buildings to the disaster area, the building units or structural components should be modular and integrated in the unopened and unassembled stage as much as possible to save space and ensure the maximum amount of transportation. However, after a disaster, the road system is usually blocked or even damaged, so in addition to land transportation, other transportation methods should be considered for disaster relief buildings, such as water or air transportation, to ensure efficient transportation and placement even when roads are interrupted, but the modularity, integration and lightness of the buildings are more demanding.
- After the disaster, the terrain in the affected area is disturbed by many external factors, and the situation is more complicated, so it cannot guarantee the conditions to open a large-scale flat open space for post-disaster resettlement, so the architectural design should be prepared to

adapt to a variety of complex terrain, for example, the height-adjustable pedestal foot setting, in the uneven terrain can be appropriate to ensure the flatness of the interior through the height adjustment of different pedestal feet, or suspension. The design can make the bottom surface of the building out of the ground, increase the surface air flow, but also to avoid a lot of heat loss in the body of the people resting indoors. At the same time, according to different climatic conditions, the shelter envelope structure and thermal environment improvement methods to make targeted adjustments is also a part of the site adaptation design can not be ignored, for example, by changing the envelope materials to adjust the shelter in cold or hot areas, such as insulation performance, waterproof and breathable performance. For example, when changing the living space of the emergency relief shelter to medical use, firstly, the scale of the building should be able to be used as temporary wards, consultation rooms and operating rooms, and the structure components should be replaced to accommodate the larger scale of the medical space, and the scale of the movable beds, the height of the surgical shadowless lights, and the space for storing medical equipment should be fully considered. Secondly, the accessibility of each function should be considered, including not to have too much threshold rise and fall, and the doors should be widened to ensure the passage of medical equipment and mobile beds.

- In recent years, with the improvement of production technology level and the scale of production, light modular buildings show large-scale development, and such buildings are widely used in civil, military, disaster relief and other fields, with good prospects for development. The biggest advantage of modular construction technology is that it can realize parallel construction, a large number of structural parts processing work is completed in the manufacturing plant, significantly reducing the amount of work in the field construction, thus shortening the time cycle of the whole disaster relief in the resettlement of victims. Not only does it reduce the difficulty of construction, better ensure the quality of construction and increase productivity, but it also reduces the cost of use by recycling building materials or repairing, reinforcing and renovating the building after use and putting it into use again.

Compared with traditional architecture, modular architecture has the advantage of simplifying complex architecture and decomposing complex functional systems into subsystems, which is easy to manage and implement³⁴. Modular building design and construction is based on the following concepts: first, it is applicable to a wide range of building types, and the construction process can meet diverse architectural and structural solutions; second, the spatial module consists of two-dimensional planar components, and all two-dimensional components can be assembled into a spatial module, which is easy to transport and flexible to build. Third, it can reduce construction waste and repeated investment, and is green. Fourth, it can reduce the amount of on-site construction and save a lot of manpower.

Thanks to its light weight, modular assembly, rapid erection and disassembly, convenient transportation and other characteristics, its application areas are not only for civilian use, in emergency relief and disaster relief and field barracks, field hospitals and other special areas of application is a unique advantage, whether in the building of rapid erection and disassembly, or functional use, living comfort and other aspects are better than the traditional military and civilian shelters.

The premise of conversion and expansion of building functions is also based on the premise of modularity of the structure. The complex situation in the disaster area requires space not only for housing of victims, medical and health care, garbage disposal, and even placement of corpses for a short period of time. In the case of damaged buildings after a disaster, emergency shelters will change the space area and adapt to new functional equipment by replacing parts and combining multiple shelters.

3.3 Key technology system

(1) Construction method

Prefabricated Prefinished Volumetric Construction (PPVC) refers to the division of a building

³⁴ Wei Wang, Chunyu Wei, Dawei Liu, et al. THE MODULAR DESIGN AND THE LOW-CARBON MODEL OF THE CONTAINER BUILDING[J]. Architectural Journal, 2011 (S1):130-135

into several modular units according to certain functions. The modular units are prefabricated and assembled in the factory with columns, slabs, walls, windows, doors, internal equipment and pipelines, and then transported to the construction site to complete the stacking and installation between the modules. As a new structural system that can achieve enhanced efficiency and rapid construction, modular building has become a hot topic of research at home and abroad. At present, the scope of application is limited to hotels, student dormitories, residences and other small space buildings.

Modular unit connection construction methods can be divided into three types: dry connection, wet connection and prestressed connection. Dry connection refers to the connection between adjacent module beams, columns or unit corners by bolts, welding or keyway cams. Wet connections refer to connections between adjacent modules through post-cast concrete wall panels or post-cast concrete floor strips. Prestressed connections are connections between adjacent modular units at the top and bottom by applying prestressing forces via screws at the corners of the modular units.

The modular units are connected to form the overall structure, and according to the overall structure form, it can be divided into the full modular structure system and the composite modular structure system³⁵. The all-module structure system consists of modular units stacked and combined to form a load-bearing structure, and each modular unit is a load-bearing space structure, i.e., the modular unit has both a force-bearing role and a use function. This system lacks diversification of external modeling of buildings, and the node connection structure is not easy to handle, and the internal space is not flexible enough. However, the prefabricated assembly rate is high and the degree of industrialization is high. For example, the Canadian "Residence 67", all building modules are load-bearing structures. Composite modular structure system mainly includes modular structure and frame structure composite structure, modular structure and core cylinder composite structure. The force-bearing function of this system is mainly borne by the frame structure and core structure, while the modular units bear the use function and part of the force transfer function. The use of composite modular structure in the building can make the building structure selection more flexible, more reasonable internal space arrangement and building exterior space modeling, and improve the structural performance and use performance of the building.

The rise of BIM technology has provided new construction ideas for cost reduction and greening of modular buildings. With the development of the industry, a large number of

³⁵ AiqunLi, TongZhou, Zhiwei Miao, State of the art of modular building system[J]. Industrial Construction, 2018, 48(3): 132-139.

traditional buildings are combined with new technologies such as BIM to effectively control the construction process, improve precision and reduce costs.

(2) Indoor physical environment optimization

In China, for example, the shelters used for temporary resettlement after the disaster are mainly relief tents that can be transported in large quantities and set up quickly, which are mainly made of canvas and waterproof fabric, with poor insulation and breathability, easily gathering heat indoors, while water vapor cannot be dissipated through the fabric, resulting in high humidity indoors and further aggravating the stifling heat. According to the visit and investigation of the livability of the transitional resettlement area of the Wenchuan earthquake relief boarding houses showed that the poor indoor thermal environment in summer was extremely common and the most unbearable problem for the victims living in them³⁶. In response, professors and scholars from several universities in China, including Sichuan University, Chongqing University and Tianjin Urban Construction University, have been working to improve the indoor temperature and humidity environment of disaster relief buildings.

Temperature is an important indicator affecting indoor living comfort, and air humidity affects the evaporation of water in human sweat, when the humidity is too high sweat will always be on the surface of the body can not evaporate into the air, affecting the decline in human body temperature and energy balance, as the emergency room or tent in disaster areas are generally directly erected on the ground and slightly less breathable, the evaporation of water vapor from the surface leads to high indoor air humidity, further reducing the human comfortable living.

In the Wenchuan earthquake, local victims added a layer of fabric on top of the tent to increase the shading of the building; the outermost layer was covered with a black heat insulation net to reduce the solar radiation heat entering the room³⁷. The air layer in the middle of the double roof can make the heat transfer resistance between the inner and outer surface of the top bigger, which reduces the heat entering the tent through heat conduction and convection; when there is wind outside, it can also take away the heat between the double roofs, so the heat insulation effect is better³⁸. This series of improvement measures make the

³⁶ Luhong Huang, Enshen Long. A Investigation on Livability of Portable Dwellings in Post-disaster Transitional Settlement Areas after Wenchuan Earthquake[J]. Building Science, 2012, 28(06):61-65.

³⁷ Tao Wang, Enshen Long, Qi Yuan, et al. Discussion on the improvement of living environment in relief tent in terms of "improvement by indigenous method" [J]. Journal of Catastrophology, 2010, 25(01):139-143.

³⁸ Tao Wang, Enshen Long, Qi Yuan, et al. Research on thermal insulation effect of double-roof tent [J]. Building

tent has obvious heat insulation effect and effectively improve the internal thermal environment.

The problem of indoor humidity is mainly caused by heavy rainfall in tropical and subtropical regions in summer. After rain, tents or temporary shelter materials such as asbestos tile roofs and untreated tricot, large core board walls will be extensively soaked with water, and even in severe cases, water will seep through the envelope, and moisture will then pass through the envelope. In addition, moisture entering the wall leads to a reduction in the thermal insulation performance of the wall, exacerbating the harshness of the indoor environment. Therefore, the envelop are given priority to waterproof panels, and the facades should be placed with a waterproof layer (such as color steel plates, tarpaulins, etc.) on the outside to avoid the invasion of outside moisture, which affects the heat insulation and durability of the wall materials. Imperfect drainage facilities around the building are very likely to accumulate water and even back up into the room, causing more humidity inside, and also affecting the indoor living comfort and hygiene conditions.

(3) Active technology and system integration



Fig. 3.1 Temporary shelters six crystalline silicon thin-film photovoltaic modules.

Source: Thermal performance analysis of an emergency shelter using dynamic building simulation

Solar emergency disaster relief buildings have become one of the most promising development directions in emergency disaster relief buildings due to their good energy resilience, and have broad application prospects in the post-disaster reconstruction and recovery process. Common material of emergency disaster shelters include plastic, canvas,

wood, composite materials or prefabricated movable panel, etc., which are characterized by small thermal capacity, low thermal inertia and poor thermal storage capacity, often resulting in large fluctuations in the temperature inside the disaster relief building and poor comfort and safety.

- The Italian company FERRINO and the Centre for Hybrid and Organic Solar Energy (CHOSE) of the University of Rome II have collaborated to design a solar photovoltaic disaster relief shelter³⁹. The researchers installed six crystalline silicon thin-film photovoltaic modules on the roof of the shelter, with a total peak power of 780W. The interior of the shelter is mainly composed of steel tubes connected and covered with a blue water-resistant tarp, which is composed of 50% cotton and 50% acrylic. Solar photovoltaic technology has solved the energy supply problem of the shelter to a certain extent, but the disaster relief shelter has the problems of poor thermal and humidity comfort and high energy consumption.
- The Federal Emergency Management Agency (FEMA) in the United States has also introduced a solar emergency disaster relief housing, the BASIP hut, which has pre-installed insulation panels in the walls and roof and a design life of 18 months. BASIP generates and stores energy through photovoltaics, obtains domestic hot water through solar vacuum collectors, regulates temperature during the heating and cooling seasons with an all-air central air conditioning system, and utilizes daylight skylights for interior lighting during the day, making it more energy efficient and sustainable than travel trailers⁴⁰. In contrast to the federal government's focus on "providing emergency shelter", local governments are more focused on the "future" and desire to provide more functional and sustainable disaster relief shelters. To this end, the Florida Solar Energy Center (FSEC) and other organizations have developed the Katrina Cottage, a modular structure that uses prefabricated panels that can withstand strong winds and rain, and a roof covered with a 4.5kW photovoltaic array and solar hot water system. This design has been

³⁹ Cornaro C, Saporì D, Bucci F, et al. Thermal performance analysis of an emergency shelter using dynamic building simulation[J]. *Energy & Buildings*, 2015, 88:122-134

⁴⁰ McIntosh J, Gray J, Fraser M. Does this cloud have a silver lining? Finding affordable housing solutions in post-disaster recovery: Lessons from Hurricane Katrina[J]. *International Journal for Housing Science & Its Applications*, 2009.

widely acclaimed for its sustainable concept, attracting many architects and resulting in more than 20 upgraded forms based on Katrina Cottage and other similar designs such as Green Mobile Homes^{41 42}.

- The US Army's Construction Engineering Research Laboratory (CERL) is working to decrease the amount of energy used by temporary barracks structures, or "B-Huts", generally. A "SIP-Hut" is the name of a prototype that is being created with structurally insulated panels (SIP). The scholars from the United States Military Academy, West Point investigated the advantages of incorporating photovoltaic (PV) panels into the SIP-Hut power system. Because SIP-Huts are typically located in remote and dangerous locations and are temporary structures, needed to power one is a unique challenge. Using the Hybrid Optimization Model for Electric Renewable (HOMER) software, the SIP-Hut was modeled, solar resources were estimated, and analysis was performed. Data showed that incorporating PV can significantly reduce the amount of diesel fuel consumed as well as the overall cost of energy production⁴³.

⁴¹ JMNigg, JBarnshaw, MRTorres. Hurricane Katrina and the Flooding of New Orleans: Emergent Issues in Shelter and Temporary Housing[J]. *Annals of the American Academy of Political & Social Science*, 2006, 604 (1) :113-128.

⁴² FX Mccarthy. FEMA Disaster Housing: From Sheltering to Permanent Housing[J]. *Congressional Research Service Reports*, 2012

⁴³ SeversonB, LegerAS. Feasibility Study of Photovoltaic Panels in Military Temporary Housing Structures[C]. *Green Technologies Conference, 2013 IEEE. IEEE, 2013*

Chapter 4 Demonstration Products of Solar-Powered Emergency Shelter

The winning design of the Solar Emergency Shelter Solutions Competition (EWG 22 2015A) incorporates innovative thin-film photovoltaic technology into the modular design of the shelter, taking into account the need for transportation, erection and living comfort. This overcomes the single, straightforward functional limitations of the classic shelter form by using solar-generated electricity and heat to power the water, heating, electricity and other equipment in the shelter. This chapter describes the manufacturing and assembly process in terms of spatial form, component connections, and technical integration. And it presents the available external equipment to ensure a safe and stable energy supply from the external energy system in extreme weather when the PV system cannot guarantee a normal power supply.

4.1 Site information

Data show that the total number of disasters in the Asia-Pacific region accounts for about 70% of the global disasters. In 2015, the APEC Sustainable Energy Center (APSEC) held a design competition for Solar Emergency Disaster Relief Buildings based on the Solar-Powered Emergency Shelter Solution (EWG 22 2015A), an APEC-funded project. The winning design was located in the city of Bitung, Indonesia, and the competition was designed to promote collaboration to enhance energy resilience and sustainability in APEC economies in the affected area. The city of Bitung's traditional electrical grid energy supply is often severely damaged in the aftermath of disasters. Providing a secure and sustainable energy supply to disaster victims in urgent need is a significant advantage of solar-powered emergency shelters, contributing to the energy resilience goals of APEC economies. A few years later, APSEC applied for an APEC self-funded project entitled "Demonstration and Promotion of Energy Resilience Tool based on Solar-Powered Emergency Shelter Solutions (SPESS) for Natural Disasters in APEC" (EWG 01 2022S), which aims to continue the previous research to provide more comfortable solar-powered emergency shelters for disaster victims in the Asia-Pacific region.

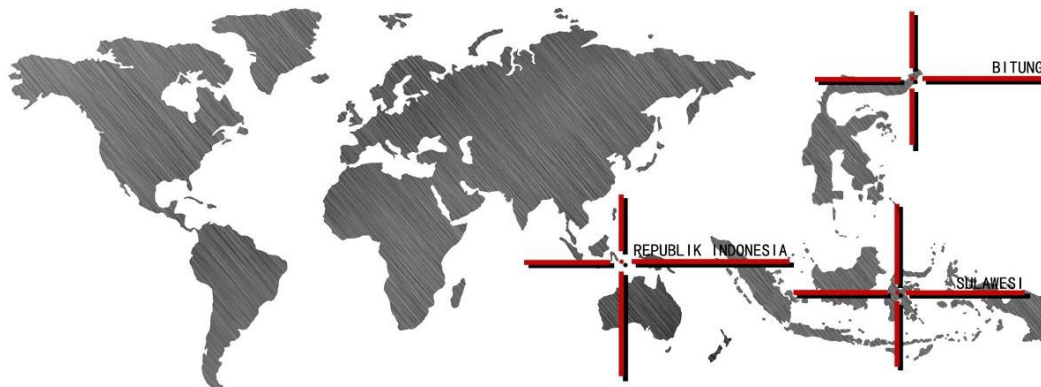

Fig.4.1 Location analysis

Source: Processing on a Map Basis

Indonesia is located in the southeast of Asia with a 35,000km long coastline. The climate is tropical rainforest with an average annual temperature of 25-27°C. Sulawesi is an island in the eastern part of Indonesia, with many deep valleys and few plains, making it the largest and most mountainous island in Indonesia. The city of Bitung is located in the northeastern part of Sulawesi, Indonesia.

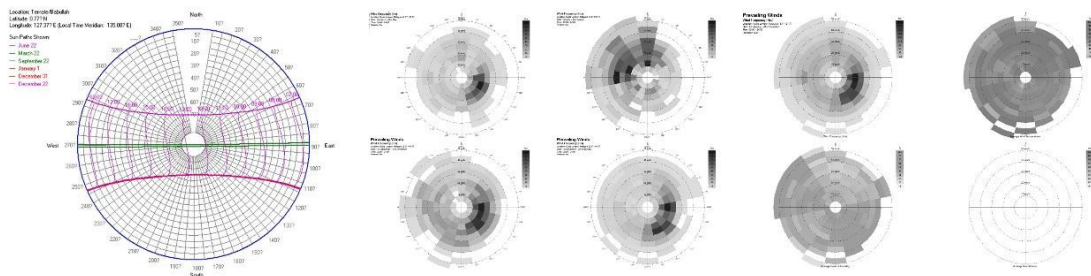

Fig.4.2 Climate environment analysis

Source: APSEC

Bitung is hot and rainy all year round, with an average annual temperature of about 26°C. The annual precipitation is about 2000mm, which is distributed relatively evenly. The city is under the control of equatorial low pressure throughout the year, and equatorial air masses prevail. Some places are exceptional due to ocean currents, etc. Although located in the tropics, most of the area is located near the equator and lacks geostrophic deflection, and has historically been virtually immune to typhoons. There are some rare exceptions, such as Tropical Storm Vamei that made landfall on Sumatra Island, Indonesia in 2001. Due to the vastness of the sea and the influence of tidal currents, humidity is high, averaging between about 70% and 90%.

Technical Review on Emergency Shelters in APEC Region

How to quickly solve the life and shelter of local people in the gap between the disaster and the reconstruction of their homes according to local climatic conditions, and build an emergency shelter with a certain quality of life has become the key to solve the problem, for this reason, the award-winning design proposes a modular solar emergency disaster relief tent design solution.

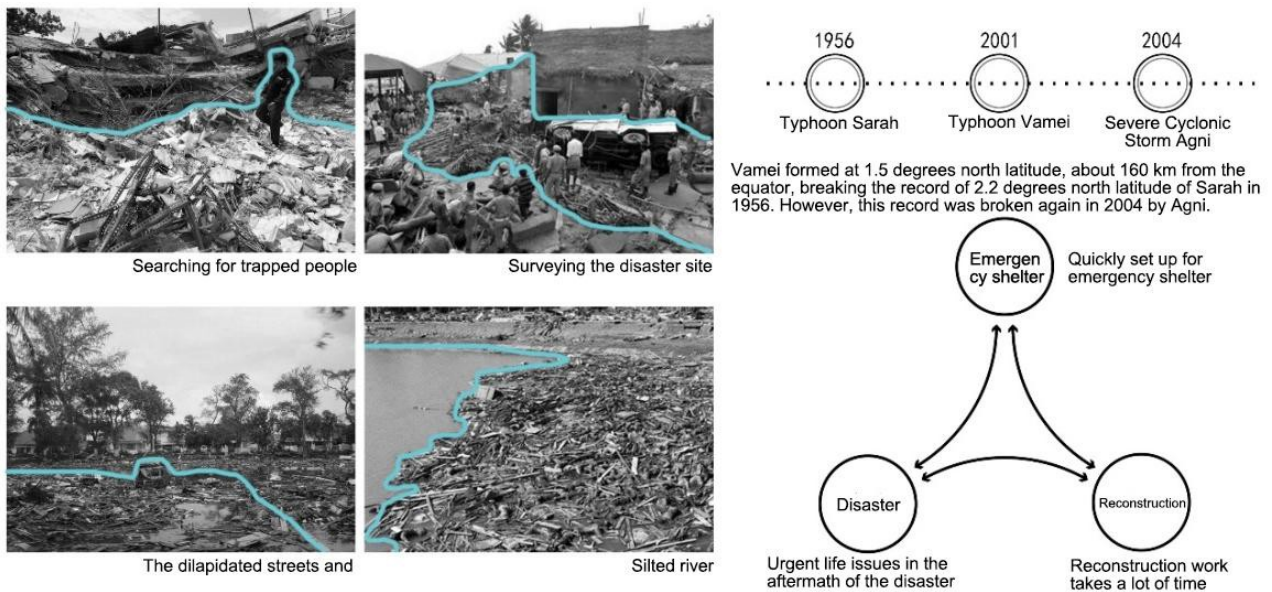

Fig.4.3 Post disaster situation

Source: APSEC

4.2 Manufacturing and assembly process



Fig.4.4 Shelter Gathering

Source: APSEC

The lightweight modular design concept is more appropriate for the design solution of a multifunctional shelter that can be swiftly put up. The innovative thin film photovoltaic technology is incorporated into the modular design of the shelter, taking into account the needs for transportation, erection, and living comfort. This overcomes the constraints of the classic tent form's single, straightforward function by utilizing solar energy to produce power and heat to supply energy for water, heating, electricity, and other devices inside the shelter.

The light modular has a unique advantage in emergency disaster relief and field barracks, field hospitals, and other special areas of application due to its light weight, modular assembly, rapid erection and disassembly, convenient transportation, and other features. It also outperforms the traditional tent in many other areas such as use of functions, living comfort, etc.

(1) Forms of space

Book's opening and closing mechanisms inspired the program's design. The new collapsible shelter design provides better living conditions than traditional tents and saves on transportation costs and human resources.

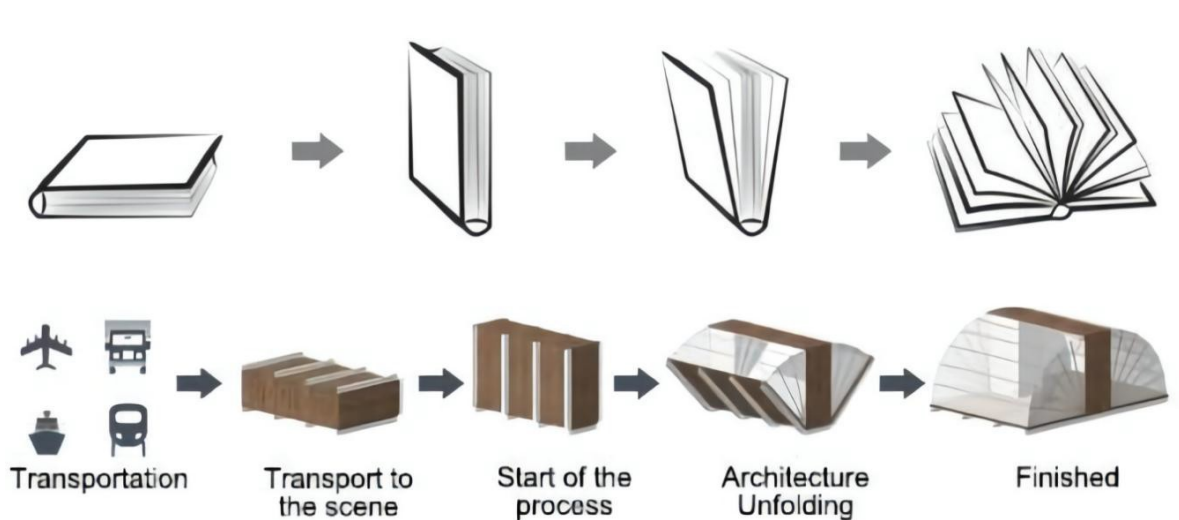

Fig.4.5 Generation of shelter space

Source: APSEC

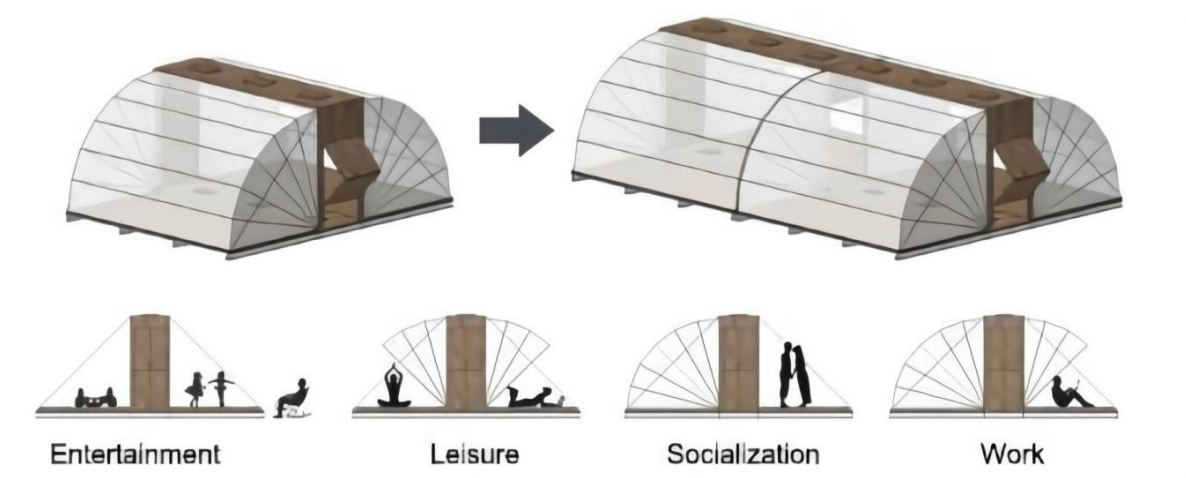

Fig.4.6 Combination mode and life scene

Source: APSEC

After all folding, the shelter is a square box measuring 6m by 1m by 2.4m. The modular design not only makes it easier to transport items using different modes of transportation, but it also enables more equipment to be pre-assembled in boxes during the production and assembly stage, ready for use right away after fast unfolding when transported to the site, saving a significant amount of time and labour costs. The energy supply problem for the inside equipment can also be resolved at any point by installing a solar photovoltaic power generation system on the outer skin of the shelter or independently on the site.

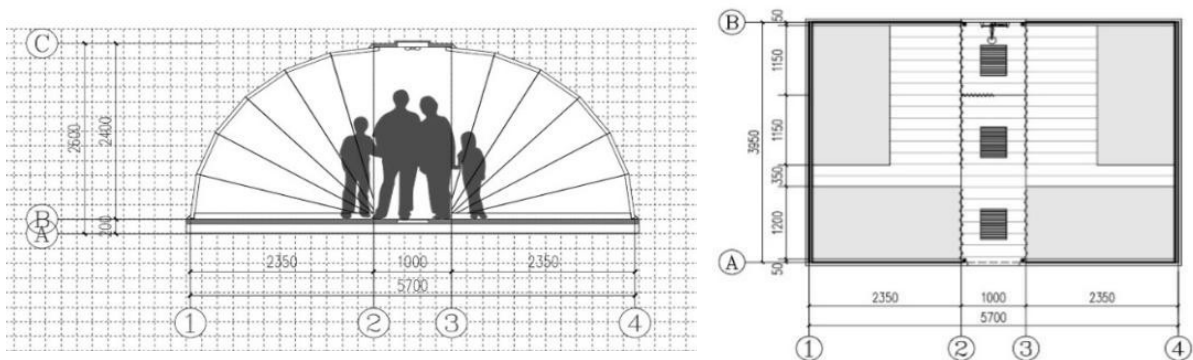

Fig.4.7 Dimensional drawings of small-scale shelters

Source: APSEC

For different functional needs, the program is designed in two sizes, $6m \times 4m \times 2.4m$ when the small scale is opened and $4m \times 1m \times 2.4m$ when folded, mainly as a living space for personnel, with a single building unit to meet the target of medium-sized families or two families of three, i.e. the number of people with a capacity of 4~6. A soft curtain can be used to separate the space in

Technical Review on Emergency Shelters in APEC Region

the middle to block the view. Because the design is elevated at the bottom, the indoor floor is separated from the outdoor ground; therefore, the internal personnel no longer need to touch the ground directly or carry a folding bed when resting, as they did with the previous tent. Additionally, the moisture-proof and warm mat built into the building can meet the personnel's daily resting use, reducing the likelihood of heat loss and illness when resting and sleeping. Even though it is a modular emergency shelter, thanks to its good folding performance, the inside size can still accommodate a normal adult without producing a feeling of claustrophobia. A simple washing area is installed inside the structure, and the sewage is released directly to the exterior via the floor drain.

The large-scale shelter, mainly used for medical and health purposes, measures 7.5m by 5.5m by 3m when it is opened and 5.5m by 1.5m by 3m when it is folded. Due to its functional characteristics, the classic field hospital square cabin requires a significant amount of space for interior activities, as well as to accommodate more professional equipment, which is more prominent in size during transportation, and typically only one square cabin can fit on a truck. The advantages of the original medical square cabin have been incorporated into the new folding square cabin, which has a lower individual space and is easier to travel. After arriving at the appointed area, the site may be immediately unfolded and set up. The replacement site can be folded up and transported straight, saving transportation expenses and considerably enhancing rescue efficiency.

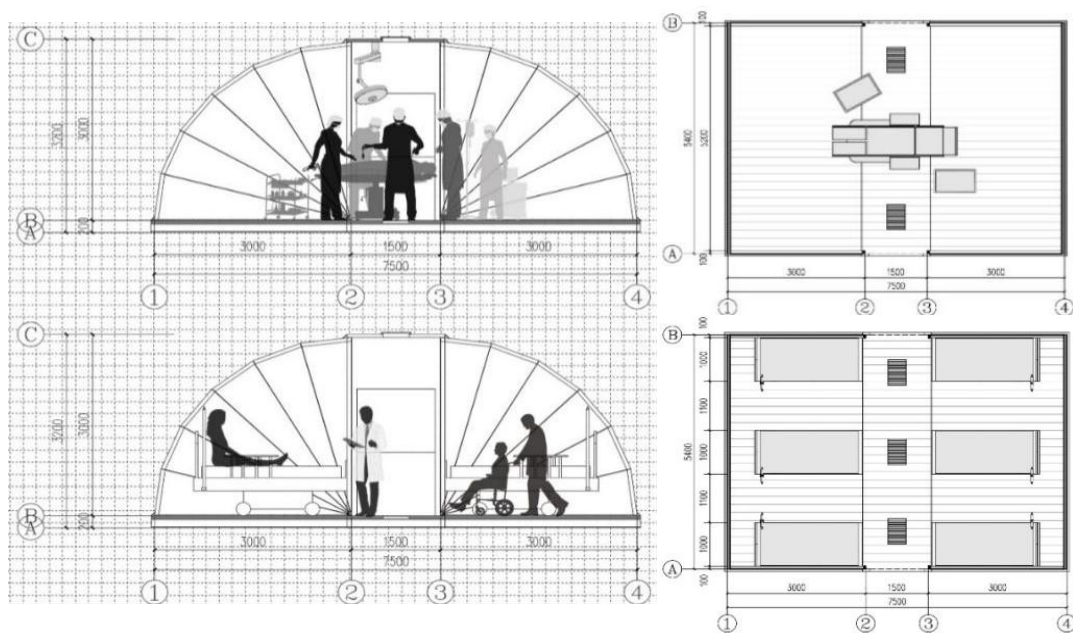

Fig.4.8 Dimensional drawings of large-scale shelters

Source: APSEC

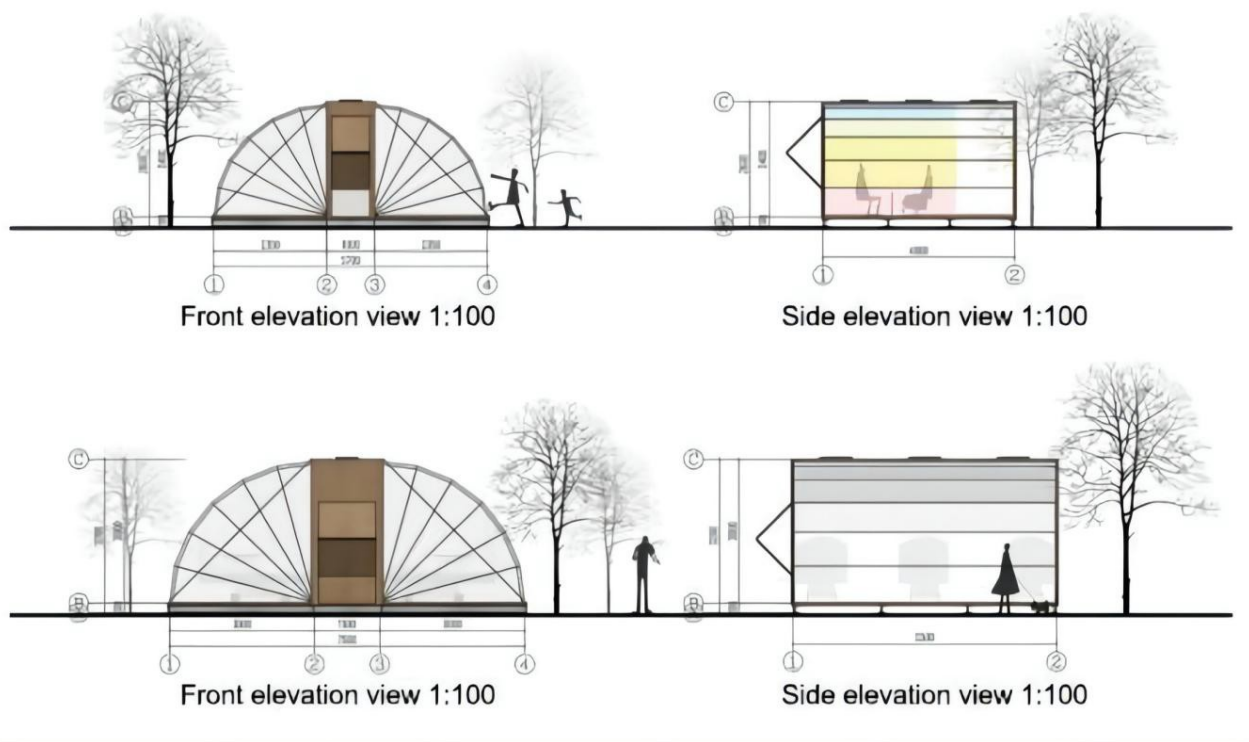

Fig.4.9 Dimensional drawings of two scale buildings

Source: APSEC

The large-scale shelter is not only an equal-scale enlargement of the small scale but also makes subtle adjustments for functional characteristics, such as increasing the height of the box so that it can accommodate the space and scale required for a small operating room in one unit; increasing the length and width of the box after folding so that it can accommodate more medical equipment in the assembly stage; and making the width of the door appropriately wider. A unit can be utilized as an operating room, a therapy room, a ward, etc. A unit may contain six mobile hospital beds when used as a ward. Additionally, many units can be joined and merged to make a comprehensive healthcare system with operating rooms, treatment rooms, and wards.

(2) Component connection

The design of the skylight was inspired by the bus skylight, which can effectively ventilate the room, while the opaque lifting roof can prevent issues like as direct sunlight entering the room and water seepage on rainy days. Ventilation fans can also be installed on the skylight to improve internal ventilation, which can efficiently drain heat from the inside when the outdoor temperature is high, ensuring that the interior is not too stuffy and enhancing the living comfort.

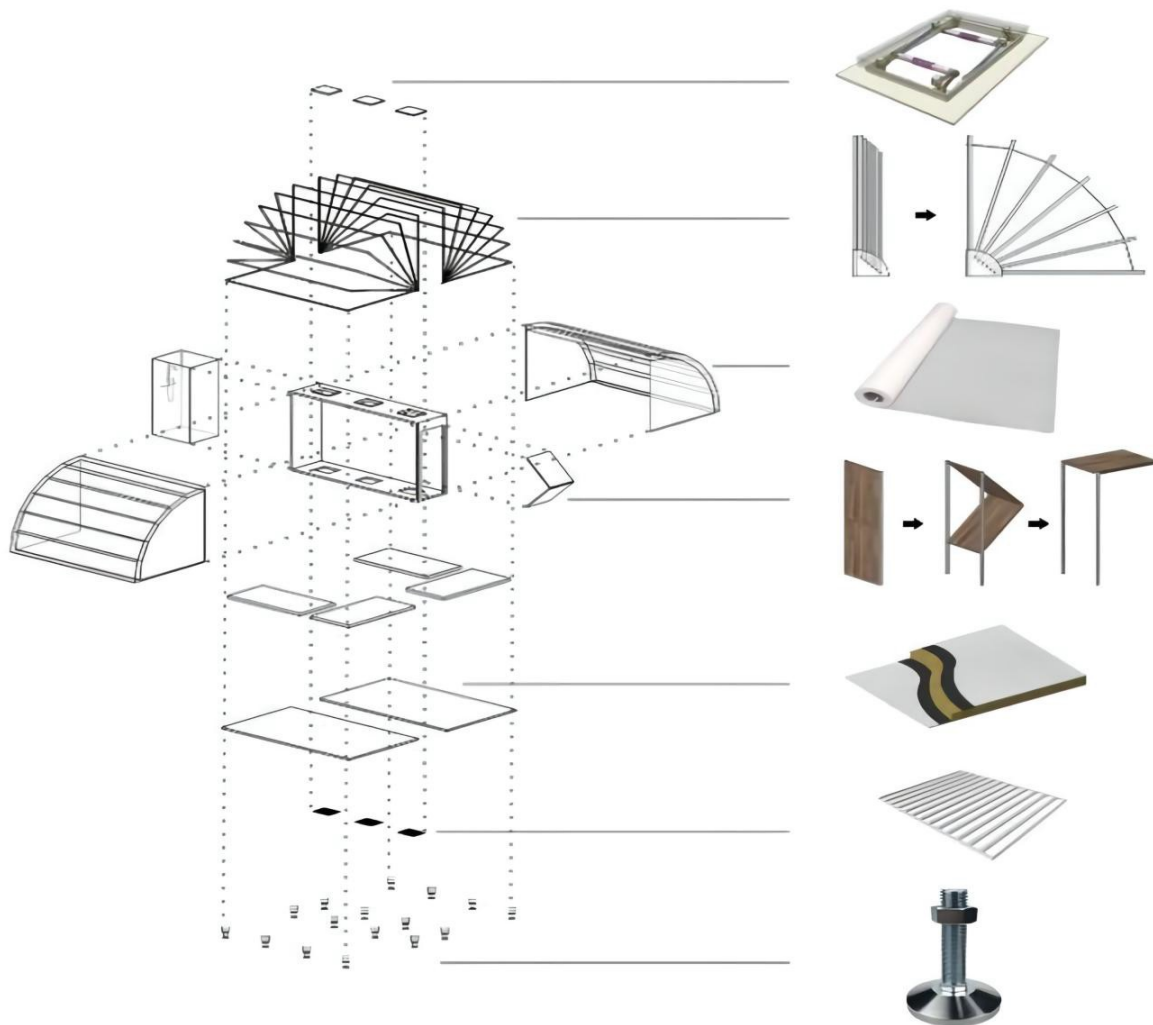

Fig.4.10 Building disassembly drawing

Source: APSEC

The connecting rods are designed to expand and close like a fan in order to give support for both sides of the membrane construction. The rods are produced from 50mm × 15mm × 3mm galvanized C-shaped steel, and each piece is fixed with wire ropes through and tightened with wire locks to guarantee that each segment has a 15° spread angle. The base is comprised of a 5mm-thick stainless steel plate with a 1/4-inch arc box, and the rod is attached to the base using an 8mm-diameter, 60mm-long, high-strength, full-tooth threaded wire rod. Lastly, the skeleton is built by putting it on both sides of the main building's open section.

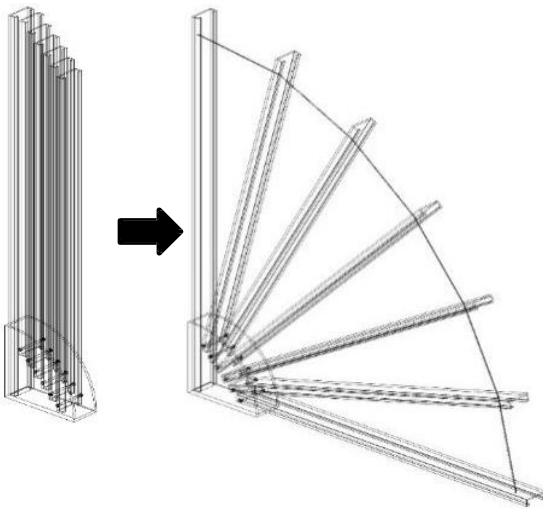

Fig.4.11 Mode and installation position of connecting rod opening and closing part

Source: APSEC



Fig.4.12 Polytetrafluoroethylene (PTFE) film

Source: APSEC

A double-layer PTFE (polytetrafluoroethylene) membrane material structure serves as the shelter's enclosure. High temperature resistance, low temperature resistance, corrosion resistance, weather resistance, non-toxic, etc. are just a few of the remarkable properties of PTFE material. It has a light transmittance of up to 95%, which can be reduced to about 50% after treatment. This material has a white frosted texture, which not only ensures uniform indoor lighting without glare but also blocks a significant amount of radiant heat from the outside to keep indoors comfortable and blocks lines of sight, giving off a good sense of privacy. The waterproof, breathable, and heat-preserving multi-layer PTFE laminated fabric that makes up the soft enclosure structure is used on both sides. The city's power grid is disrupted after the disaster, gathering people to the evacuation site as if the fire of life and hope is rekindled, comforting the victims' hearts. At night, the electricity saved during the day powers the indoor lights and equipment, and the light shines softly and evenly through the enclosure.

The outer door of the shelter uses a sliding rail folding upward design, which takes up less space while opening compared to a flush door, and may also be utilized as a canopy for the shelter's entry once it is open.

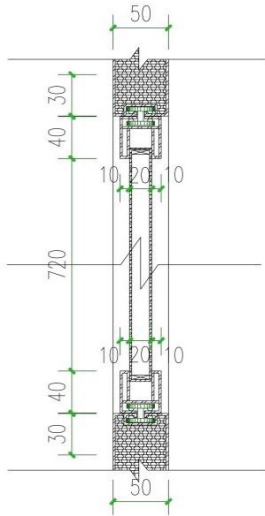

Fig.4.13 Cross section of sliding door
Source: APSEC



Fig.4.14 Schematic diagram of sliding door opening and closing mode
Source: APSEC

The main frame consists of 50mm × 50mm × 5mm L-shaped aluminium alloy that is welded or screwed together to form a 6m × 4m × 2.4m square frame that serves as the main building's supporting structure skeleton. The outer envelope panel is comprised of a 50mm-thick foam-coloured steel sandwich panel, and it can be wrapped with a layer of waterproof wood on the outer side to reduce heat transfer, extend the service life of the core board, and create a beautiful effect. Multiple steel strips can be added to the bottom plate as ribs to increase its supporting strength.

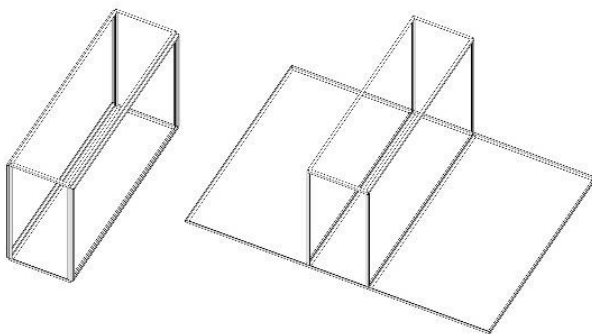

Fig.4.15 Building disassembly drawing
Source: APSEC

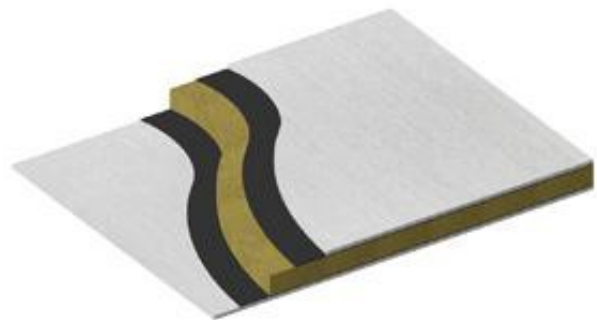

Fig.4.16 Exterior envelope panel construction
Source: APSEC

The design of floor drains can expedite the ventilation effect in a room and, in conjunction with skylights, create a chimney effect of thermal pressure ventilation that can expel the room's heated air. Simultaneously, the room's wetness may be immediately released to the exterior via the floor

drain to keep the room dry and create a more comfortable living environment for the occupants.



Fig.4.17 Floor drain design

Source: APSEC

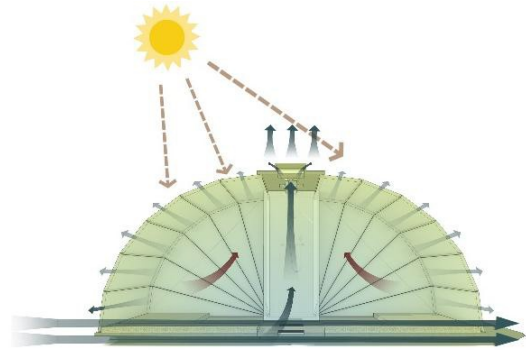

Fig.4.18 Schematic diagram of indoor ventilation

Source: APSEC

The base overhead support structure is an all-metal adjustable mechanical fixing assembly that, on the one hand, allows for base overhead construction without significantly increasing building volume or weight and, on the other hand, allows for manual height adjustment by being manually suspended and screwed. Additionally, each component can be adjusted independently, allowing for flexible adaptation to a variety of complex ground environments and ground undulations. This allows the building as a whole to adapt to a wider range of field terrain conditions while maintaining indoor flatness and building stability. The raised design also prevents the effects of muddy outdoor ground on the interior sanitary conditions and living space of the building in wet and snowy weather.



Fig.4.19 Metal fixed skirting

Source: APSEC

The chosen panels are sandwiched insulation panels that are 50mm thick, consisting of two layers of 0.5mm color steel plates and a center layer of 50mm thick polystyrene foam. At the factory, the panels were created and cut in accordance with the design specifications. The finished products consist of two pieces measuring 2000mm × 590mm × 50mm for the top and bottom of the shelter, two pieces measuring 1100mm × 590mm × 50mm for the building's wall, one of which has a cutout for a doorway measuring 900mm × 400mm, and two pieces measuring 2000mm × 1150mm × 50mm for the shelter's opening and closing surface, which is unfolded for the floor of the shelter and it closes to form a complete box. Finally, 50# C-type aluminum was added to the panels' perimeter to increase their structural integrity.



Fig.4.20 Manufacturing of plates

Source: APSEC

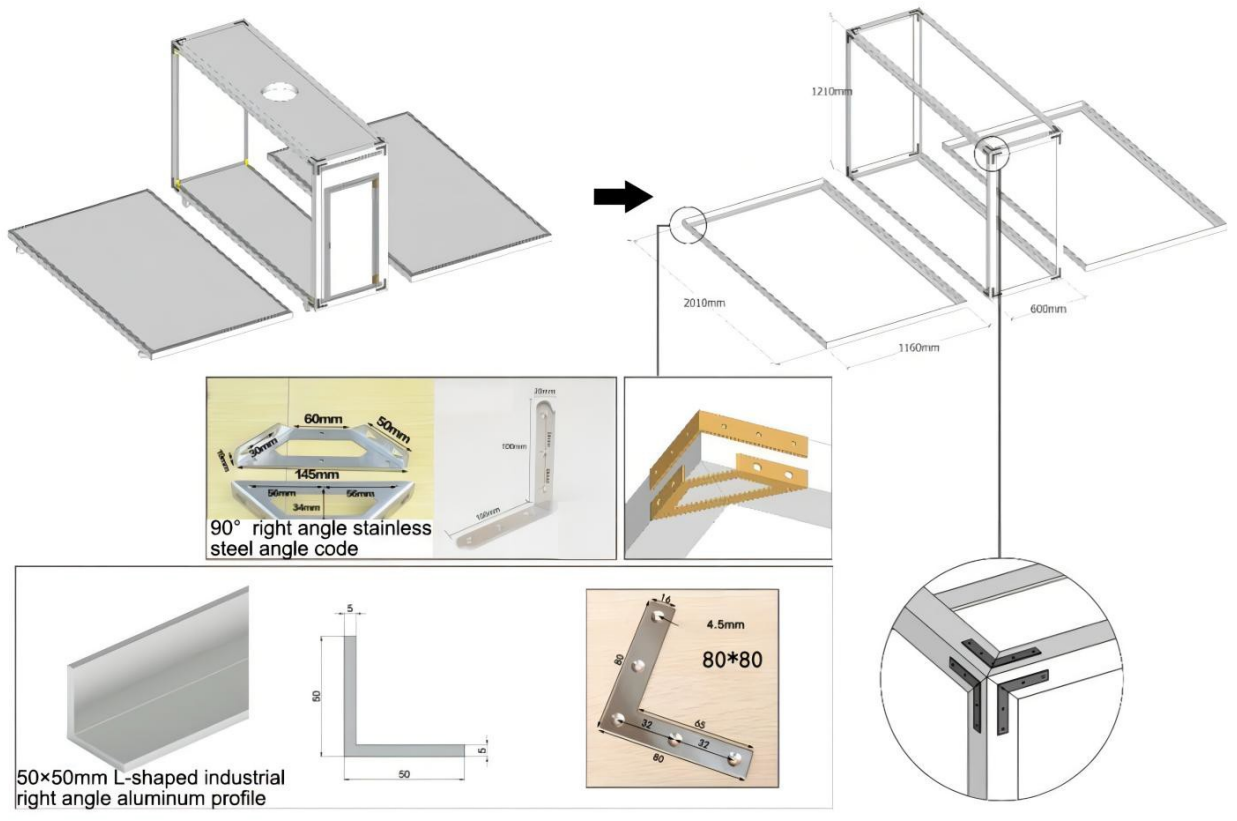

Fig.4.21 Connection of shelter frame

Source: APSEC

Considering that the building has certain load-bearing requirements, in addition to the connection of the plates, the outer side of the box is added with 50mm × 50mm L-shaped industrial right-angle aluminum profiles as the frame to minimize the weight increase of the shelter and at the same time enhance the structural strength of the whole box, and the aluminum profile frame is also convenient for the connection and installation of other attached parts on the building. Considering the modular assembly factor, the welding method is not chosen for the connection part of the plate and frame, but the bolt anchoring with right-angle stainless steel angle code and L-type connector, which is convenient for the maintenance and replacement of building rods and link materials at a later stage.

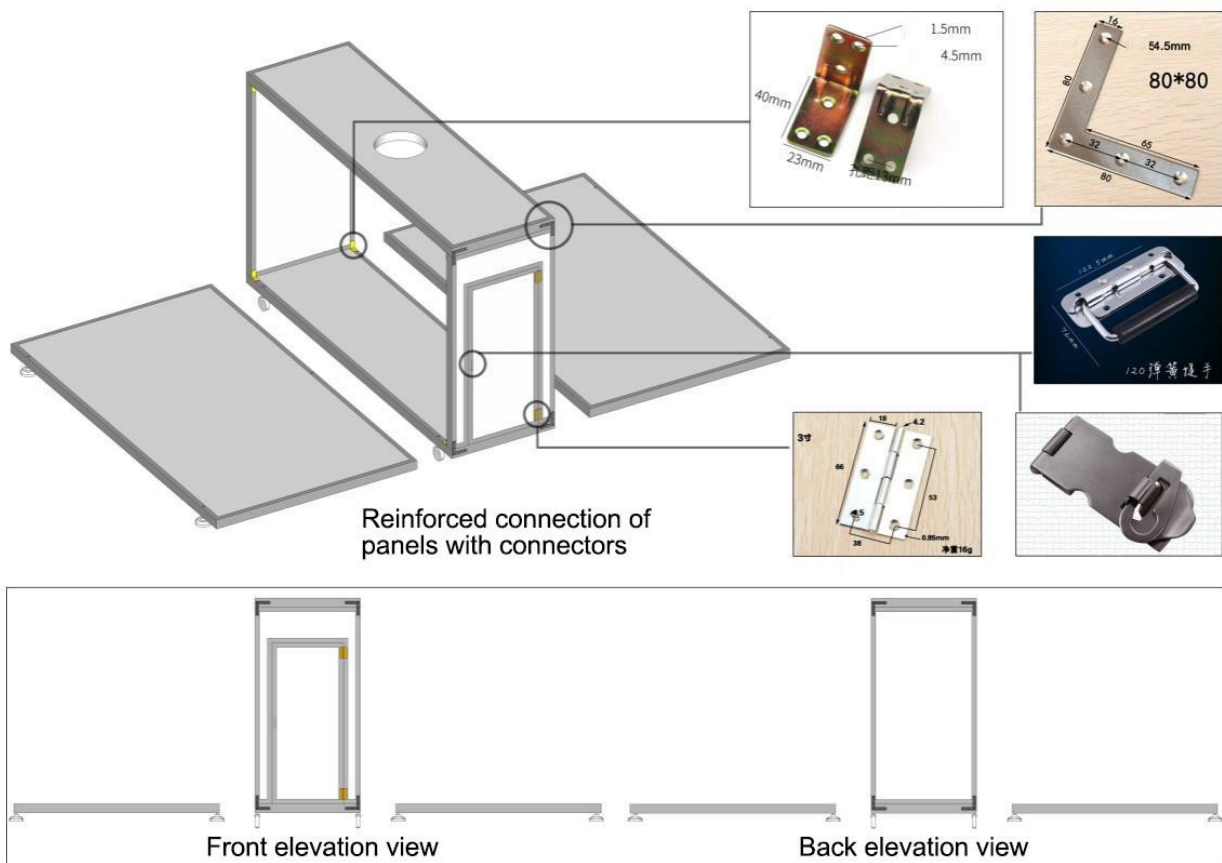

Fig.4.22 Shelter frame joints

Source: APSEC

In the main box at the bottom of the four corner position installed 3 inch silk tooth screw universal wheel, whether it is the experimental process or the actual construction can be convenient to move and transport, the bottom of the fixed lock fixed wheel, can be placed after the completion of locking the wheel, will not slide at will. The side opening and closing panels are installed at the bottom after unfolding with the specification of chassis diameter 60mm all-metal adjustable mechanical fixed kick to support the bottom surface after unfolding, and the adjustable up and

Technical Review on Emergency Shelters in APEC Region

down seat foot design can make proper height adjustment at the placement site to keep the building stability and indoor flatness in the construction and placement of a variety of complex terrain.

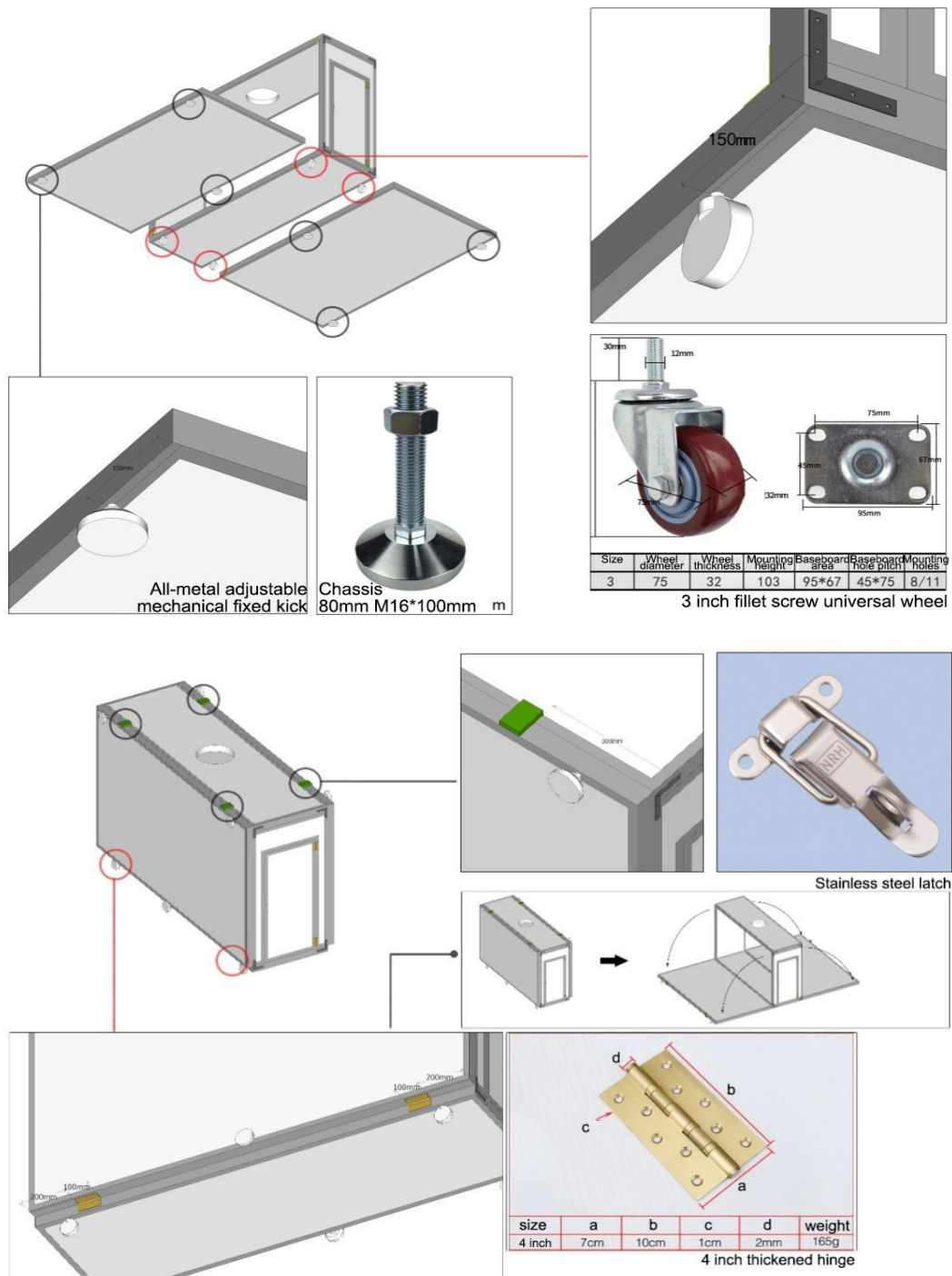

Fig.4.23 Shelter accessory parts

Source: APSEC

Both sides of the opening and closing surface plate using 4-inch 3mm thick stainless steel hinges at the bottom and the main body of the shelter to connect, in the upper use of stainless steel latch, after closing can be very good lock plate will not open at will.

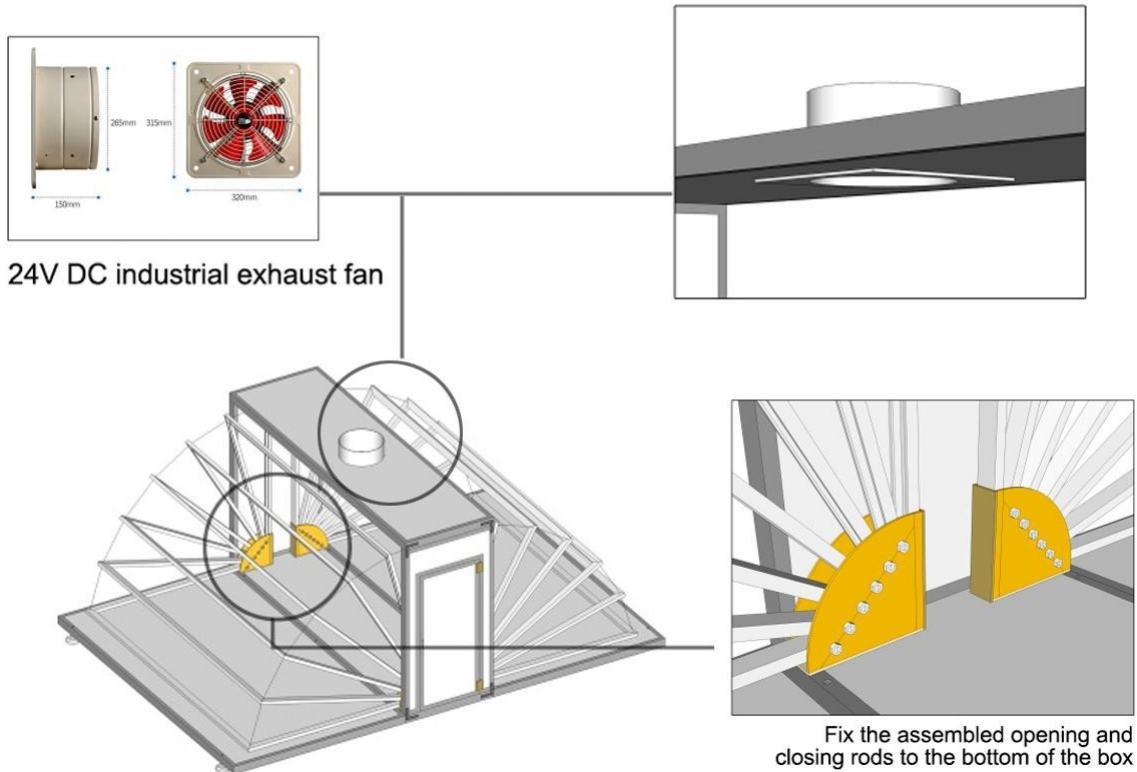

Fig.4.24 Fan and bearing box

Source: APSEC

The ventilating fan selects 24V DC inverter industrial exhaust fan, which is mainly used to ventilate and dissipate heat indoors, the speed can be adjusted at will between 300rpm and 2850rpm, and the maximum air volume is 2500m³/h (about 0.694m³/s), the inverter is chosen mainly to select the best ventilation rate during the experiment, and also to avoid unnecessary energy consumption caused by single-speed operation. 24V operation voltage, 50W output power and 110V~240V power adapter ensure that the fan can run well whether it is connected to the city grid or through the battery, saving energy and protecting the environment. At the same time, it is far below the safety voltage of 36V to ensure the safety in the process of use. The minimum operating noise of the fan is no more than 40db, which is lower than the standard of less than 45db for ambient noise in residential areas at night.

Technical Review on Emergency Shelters in APEC Region

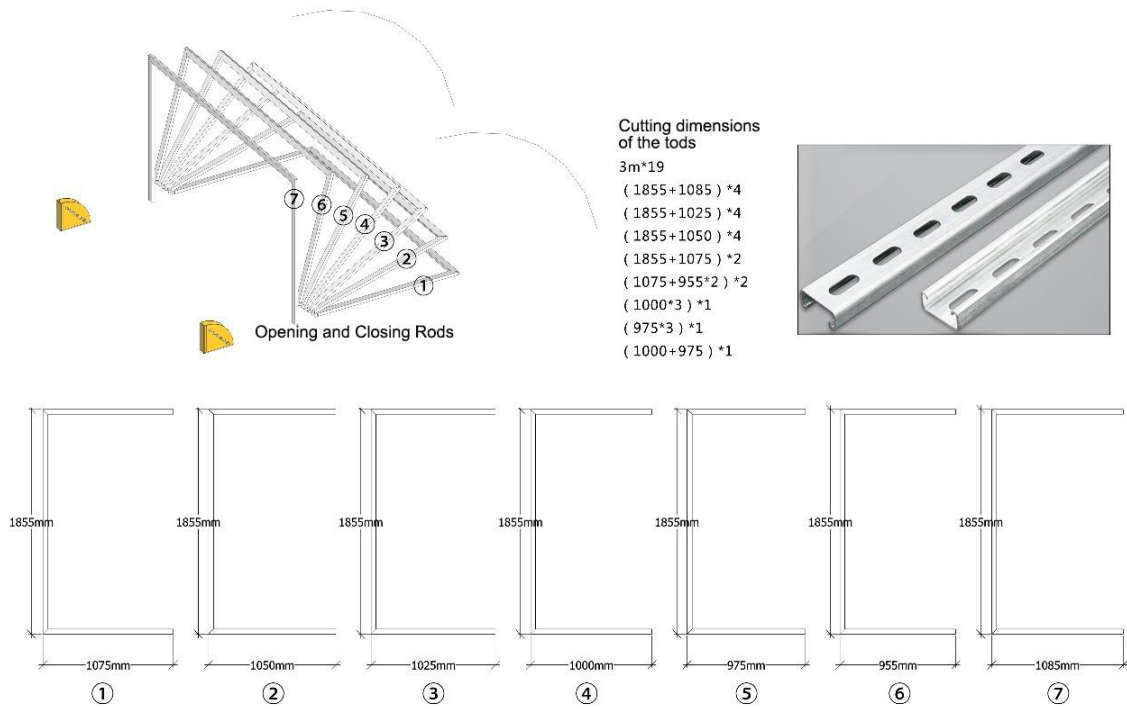

Fig.4.25 Opening and closing bars

Source: APSEC

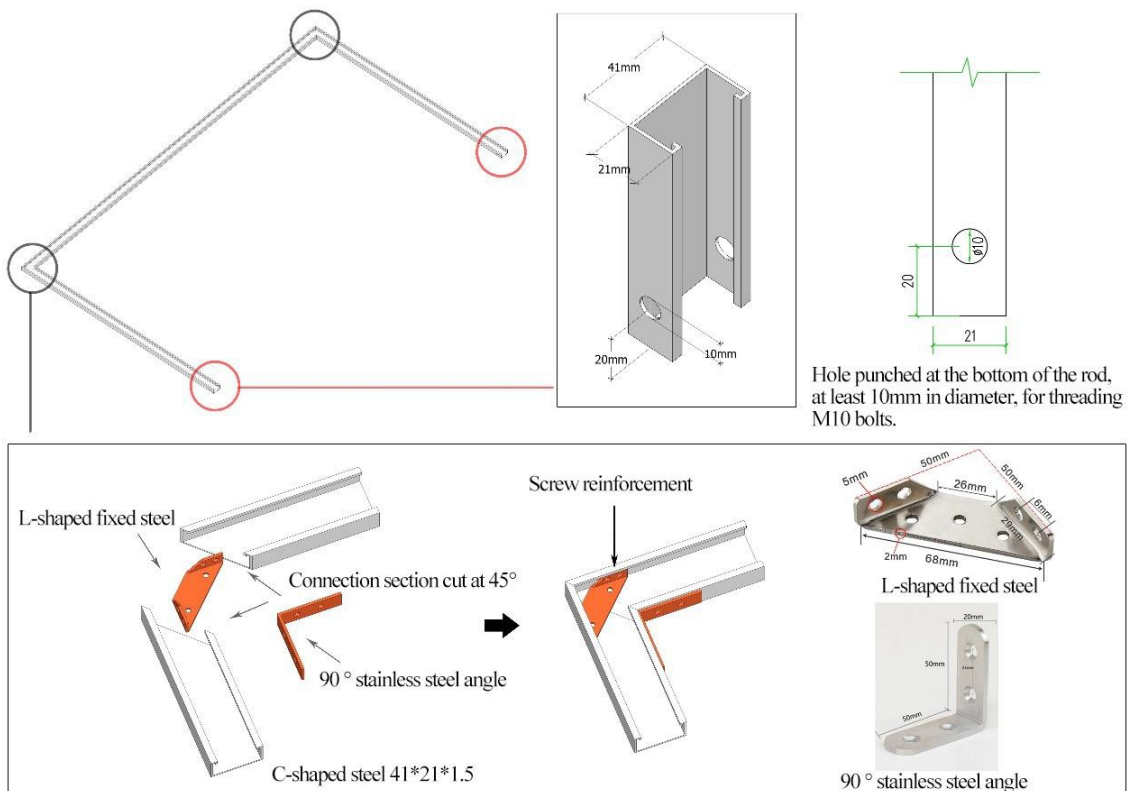

Fig.4.26 Specific design dimensions and connection methods for opening and closing bars

Source: APSEC

The main structure of the building is divided into an expandable box and a collapsible skeleton, while the latter is divided into three main parts: the opening and closing bars, the bearing box and the wire rope.

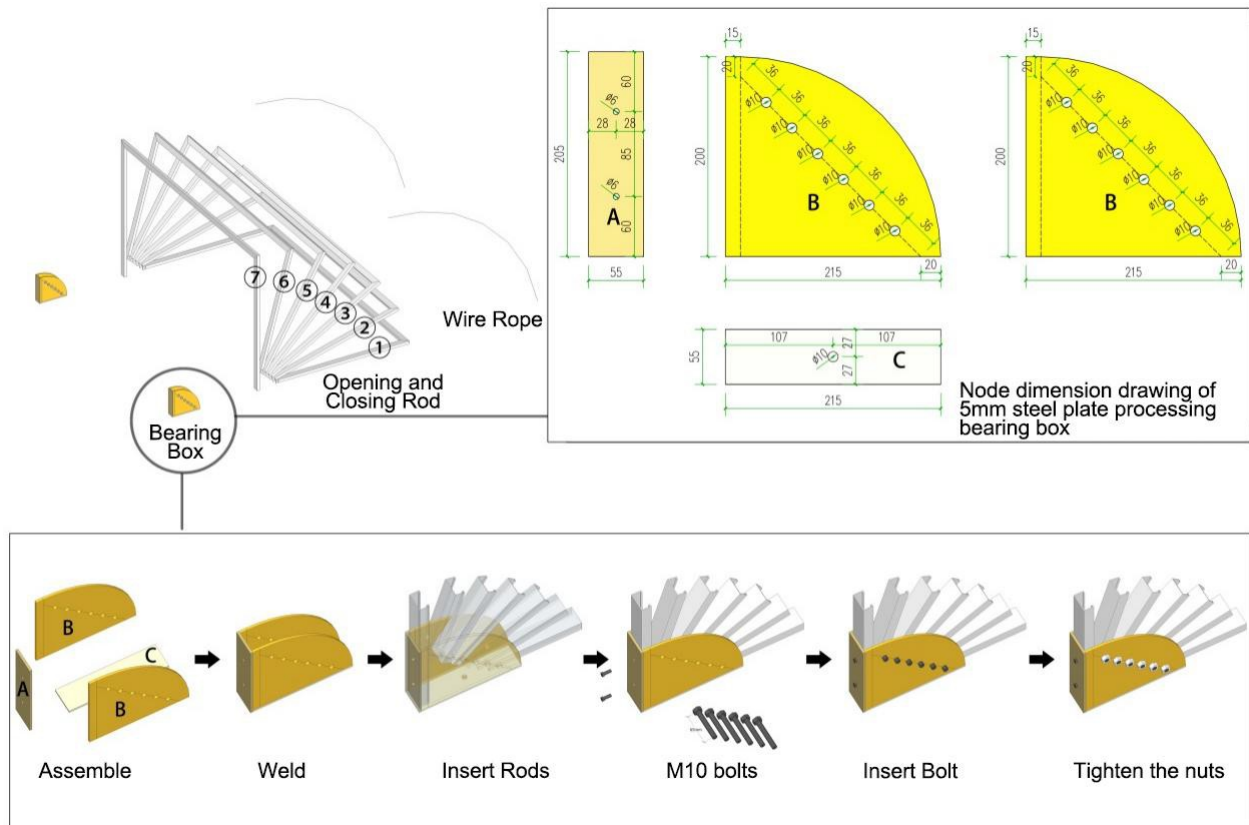

Fig.4.27 Bearing box node

Source: APSEC

The opening and closing rods are made of 41mm×21mm×1.5mm perforated galvanized C-section steel, cut according to the dimensions in the figure, with 45° opening cut at the connection point, and bolted with two different sizes of L-shaped stainless steel angle codes for later maintenance and replacement of the rods. M10 holes are cut laterally at the bottom of each group of rods on both sides for threading M10 bolts to connect with the bearing box to form a fan-shaped hole that can be opened and closed. The bearing box is divided into three sides of A/B/C, all made of a 5mm thick steel plate after laser cutting. The four sides cut are placed and welded to form a complete bearing box according to the drawing, the opening of A plate is directly connected to fix the No.7 rod, and the opening of two B plates is pierced with bolts to connect the role of the rod, the opening of C plate is connected with the bottom of the box through bolts to fix the two groups of open and close rods to the inside of the box, and finally connected in order to form the whole according to the steps of the drawing. The last wire rope and wire rope bayonet play a role in the opening and closing part of each group of rod opening and closing angle control at about 15° to

ensure that the final opening and closing angle of the entire rod combination is evenly open, the overall become a 90° opening and closing state.

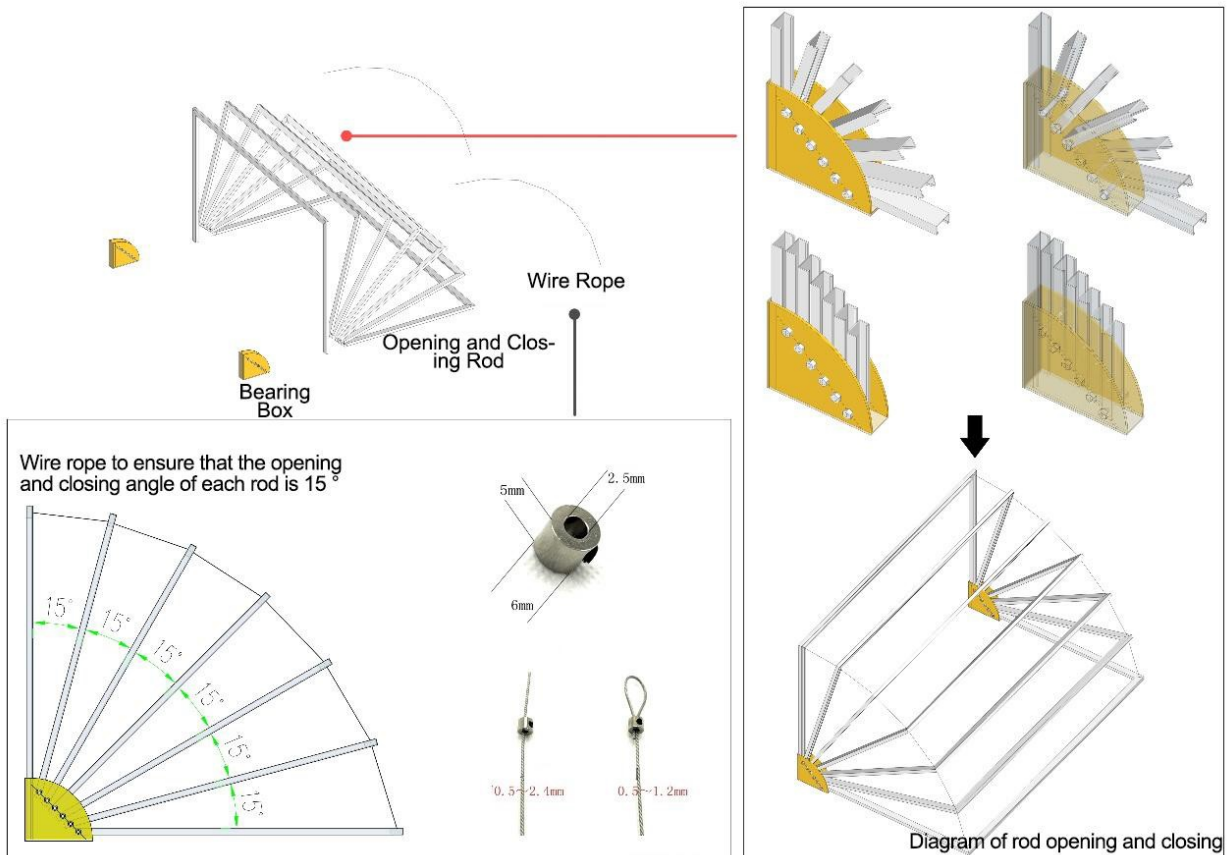

Fig.4.28 Critical node processing

Source: APSEC

Finally, the outermost maintenance structure after the shelter unfolding is installed, PTFE film with a width of 1m and thickness of 0.2mm is cut and paved according to the size, and the connection with the rod is made by punching holes on the film and the rod, and the film is fixed to the rod with M5 screws and nuts, which provides good support for the fixing of the flexible PV module on the film. The lateral direction is due to the need to increase the ventilation and heat exchange effect of the room, as well as the need for materials with a certain degree of ductility and shrinkage, so the side materials choose spandex fabric, the PTFE film above the side down roll fixed, so that it enhances the rainproof of the building, spraying nano-waterproof spray on the spandex, and it has a better breathable effect while increasing the water resistance of the fabric, later on, we can also change the material according to the experimental effect, add air interlayer and other measures to improve the thermal performance of the building.

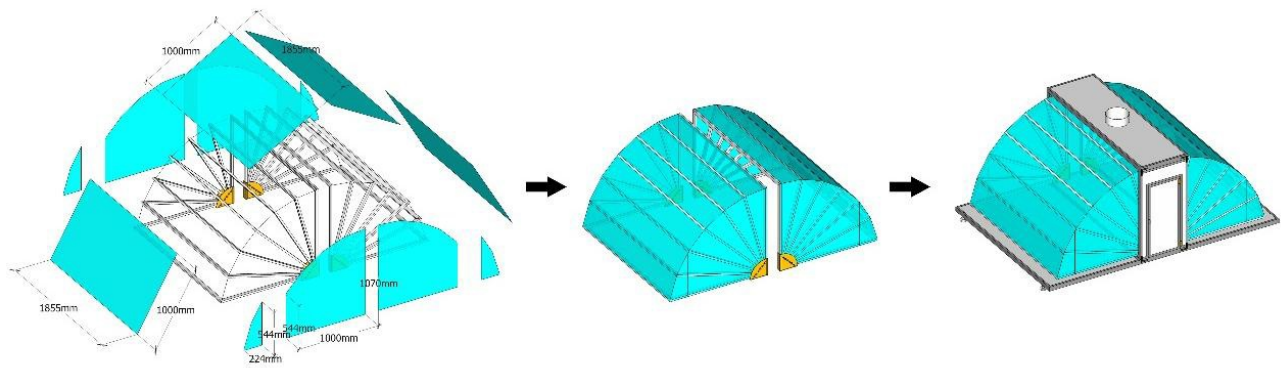

Fig.4.29 Cutting size and paving diagram of PTFE film

Source: APSEC

(3) Technology integration

At the technical level, the building can use solar energy and other clean energy systems to provide electricity or heat for indoor equipment. The specific form can be in the form of thin-film photovoltaic cells laid on the exterior surface of the shelter, flat-panel photovoltaic on top of the shelter or centrally arranged photovoltaic and photo-thermal panels around the site, which can ensure the electricity demand of the equipment in the building at any time. Even if it is cloudy, the power generation is less, but it can partially relieve the pressure of power supply of generators in the field environment. The shelter can also be built with small water collection and purification devices to temporarily solve the problem of drinking water for personnel in case of insufficient water supply.

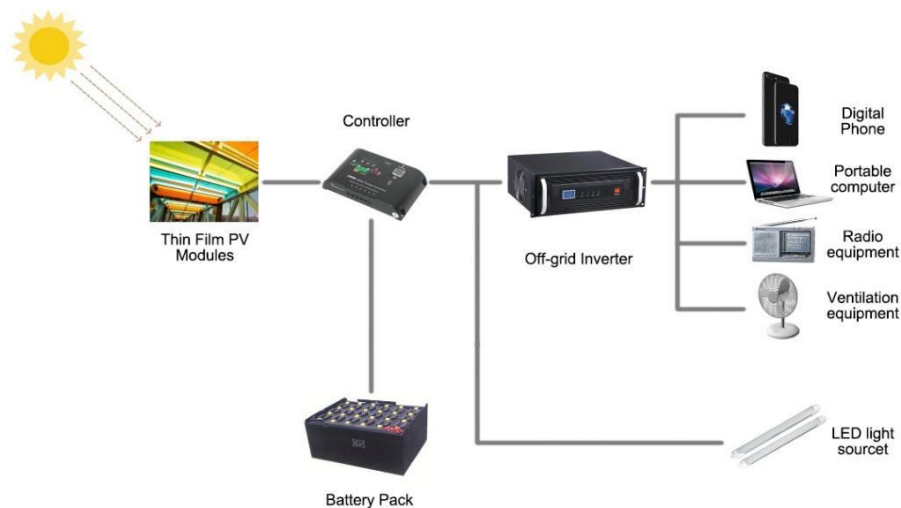

Fig.4.30 System diagram of shelter energy supply and demand

Source: APSEC

The flexible thin film PV modules are made of Hanergy's Mia Sole FLEX CIGS, and the data are more in line with the laying requirements of the solar emergency shelter practice program. Because the thin film surface between each purlin on the upper side of each pole needs to be folded when the building unfolding surface is closed, the actual 1:2 model is mostly within the main frame after the top piece of the six top surfaces are built, so in the actual design, only the five top surfaces below are retained as the laying surface of the flexible film PV.

Each unfolded surface is divided into two parts, and each PV module is 120mm×1800mm in size, and is laid on the unfolded surface in two pieces, leaving a gap of 10mm in between, so as to ensure that the two modules are folded with the film when folding, while the PV module itself does not have to be folded.

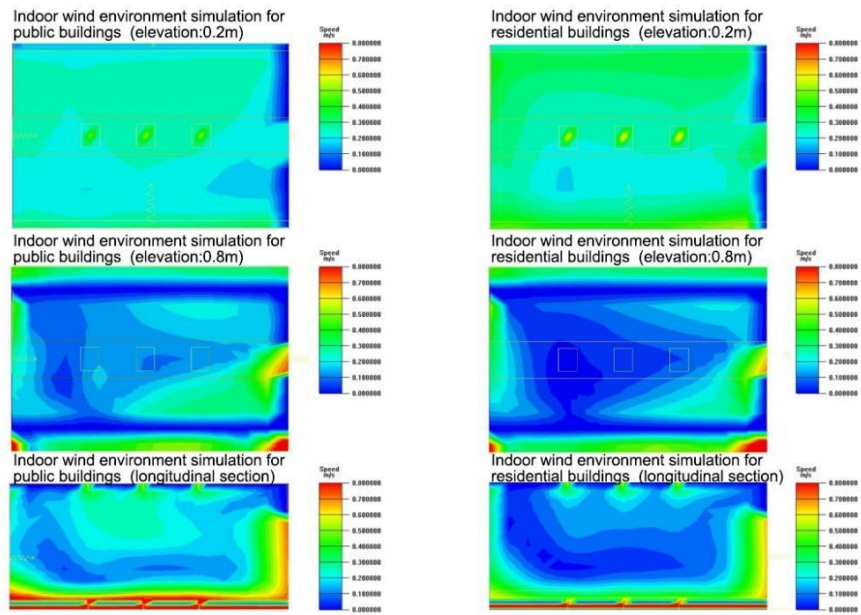

Fig.4.31 Indoor wind environment simulation

Source: APSEC

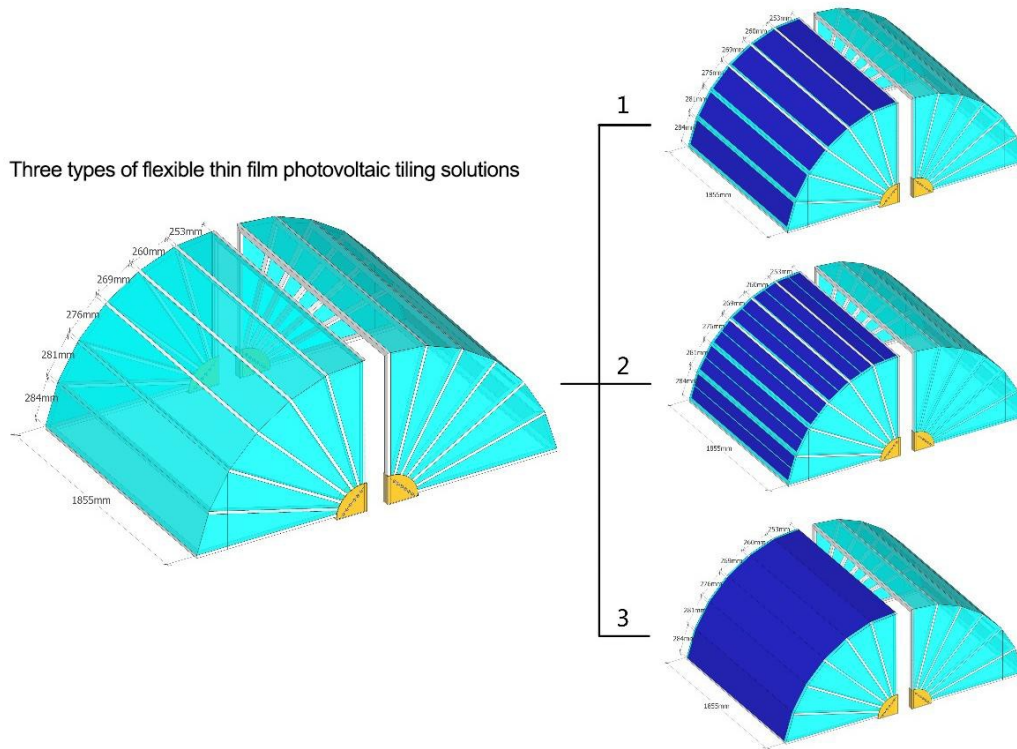

Fig.4.32 Flexible thin film photovoltaic paving

Source: APSEC

Option 1

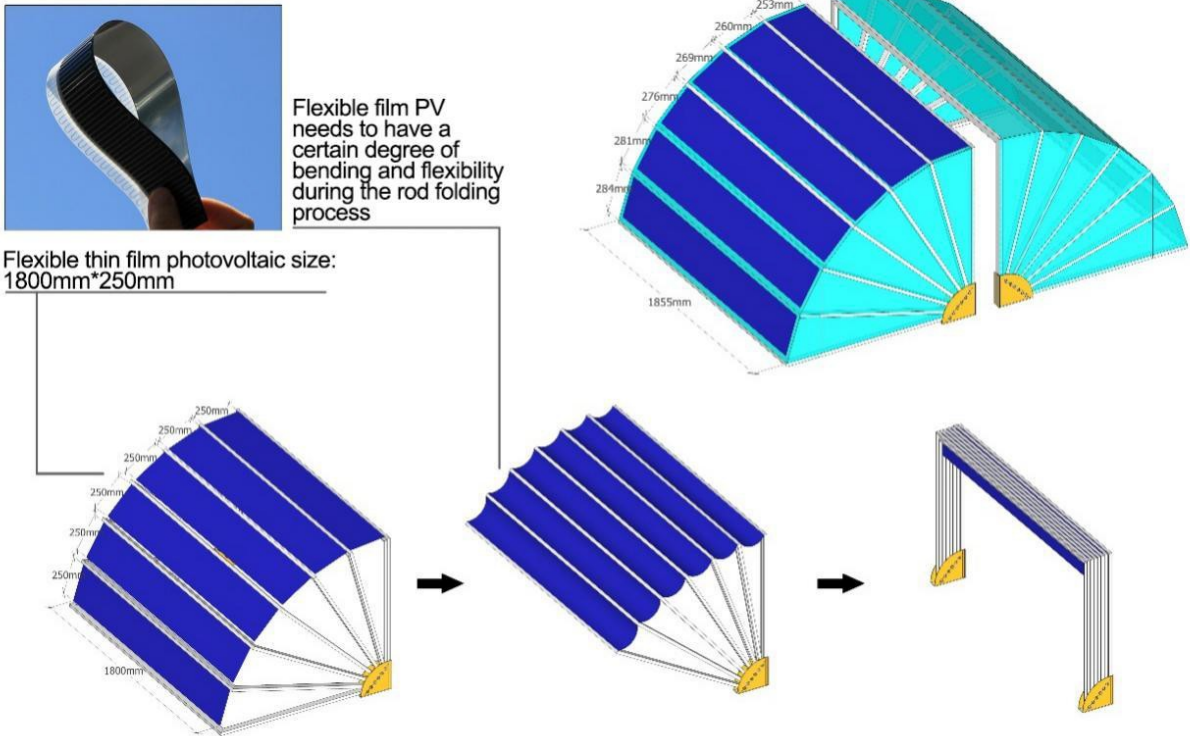

Fig.4.33 Flexible thin film photovoltaic paving: Scheme

Source: APSEC

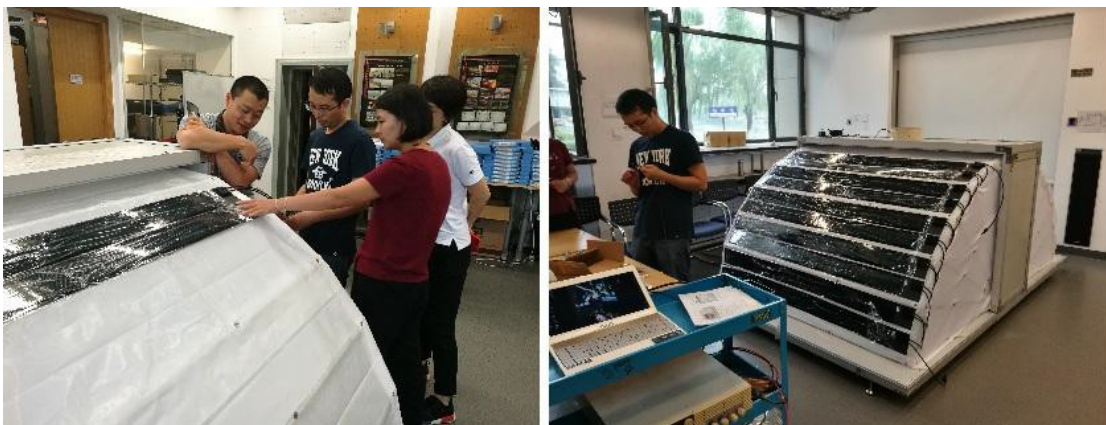

Fig.4.34 Paving process of flexible thin film photovoltaic

Source: APSEC

The connection method of the test system mainly involves energy balance monitoring and comfort monitoring, and the three systems of power generation, power consumption and outdoor environment monitoring are tested independently when conducting experiments to ensure the accuracy of the data.

Technical Review on Emergency Shelters in APEC Region

The power generation system is to connect the flexible thin film PV module system to the DC electronic load and then connects the load to the computer side for data monitoring of power generation and power generation characteristics; the power consumption system is to connect the multi-functional digital display DC tester to the motor power line, which is used to test the actual power consumption of the wind turbine in the experiment and the total power consumption throughout the day.

The PC-4 portable automatic weather station is connected to the computer terminal to measure the outdoor ambient temperature and wind speed data. The exhaust fan operating wind speed and indoor wind speed are detected using the HCJYET HT-8398 thermal anemometer, and the measured data are recorded in real-time. Indoor temperature was recorded in real-time using CEM DT-172 temperature and humidity tester, and the data was summarized and exported through its software Datalogger. The temperature of the flexible thin-film PV ground back sheet is monitored by AZ88598 four-channel temperature logger connected with a thermocouple placed under the ground back sheet, and the data is recorded on the SD card in the machine, which can be directly copied to the document file by connecting to the computer.

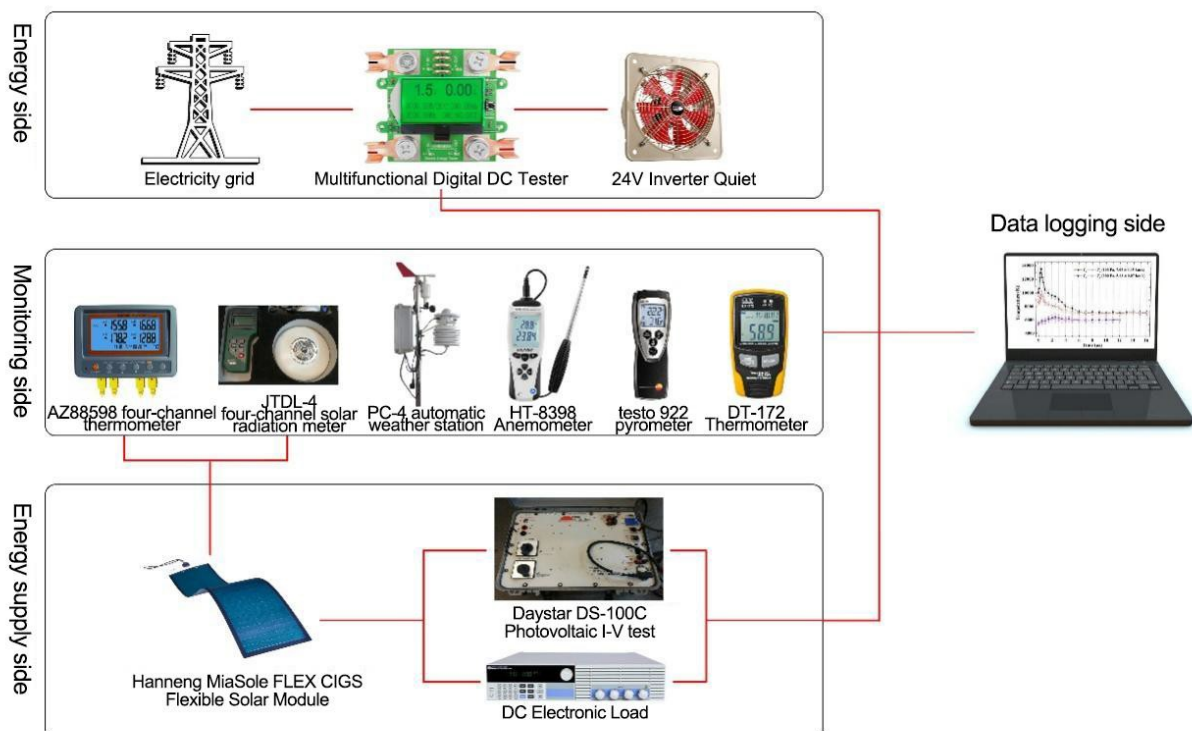

Fig.4.35 Test system connection diagram

Source: APSEC

The main purpose of energy consumption monitoring in the shelter is to achieve a power generation that is not less than the power consumption and to ensure that the energy provided through the green power generation energy system will be enough to meet the electricity needs of the room. The test period was two days on September 8 and September 9, 2018. The completed solar emergency disaster relief building experimental platform was unfolded and placed on the open and unobstructed flat ground in the south of Tianjin University School of Architecture, and the side of the shelter equipped with flexible thin-film photovoltaic was placed facing south in order to maximize the use of solar energy, and whether the requirements were met was finally obtained through the recording of the experimental data of both power generation and electricity consumption.

- Obtain the power generation characteristics of the PV for a day and calculate the total power generation for each day by recording the flexible thin film PV power generation data by DC electronic load and computer.
- According to the determination of the fan ventilation rate to record the operating power of the fan at this time, and calculate the power consumption of the ventilation fan a day.

In the experiment of PV power generation efficiency and indoor temperature detection on September 8, the fan ventilation rate was adjusted to the best position, and the data changes from 5:00 to 19:00 on that day were recorded, and the PC-4 portable automatic weather station was connected to the computer to measure the outdoor ambient temperature, wind speed and other data. To avoid the error of the experimental results caused by the uneven distribution of indoor temperature, the indoor temperature detection was performed by using CEM temperature and humidity tester DT-172, and the frequency of recording was once every 5 minutes, and the final summary data was organized into a chart.

On September 9, the effect of photovoltaic connection method on power generation was tested, and the IV curves of five groups of flexible photovoltaic films with different angles were tested for photovoltaic conversion efficiency. The test was conducted on September 9 from 9:00 to 15:00, once every hour, to ensure that the solar irradiance remained in a relatively stable state during the measurement process.

For the power generation characteristics, experiments on the power generation characteristics of PV modules were also conducted on September 8 and September 9. The overall power generation characteristics and total power generation of PV modules under series connection conditions were tested on September 8, and the comparison of PV power generation efficiency and the

photoelectric conversion efficiency and I-V curves of five groups of flexible thin film PVs with different angles were tested on September 9 under both series and parallel connection methods.

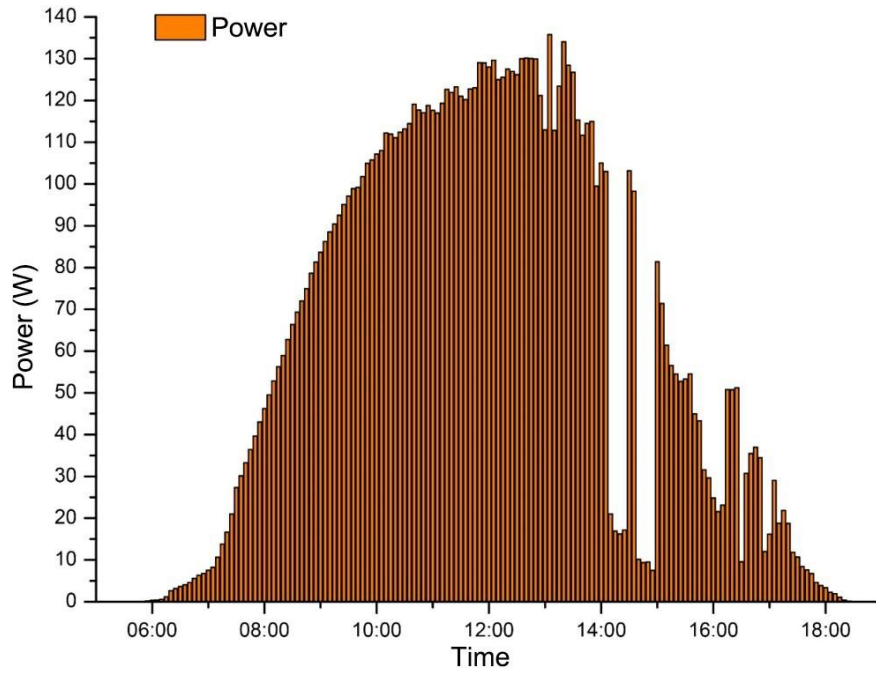

Fig.4.36 Power diagram of photovoltaic power generation

Source: APSEC

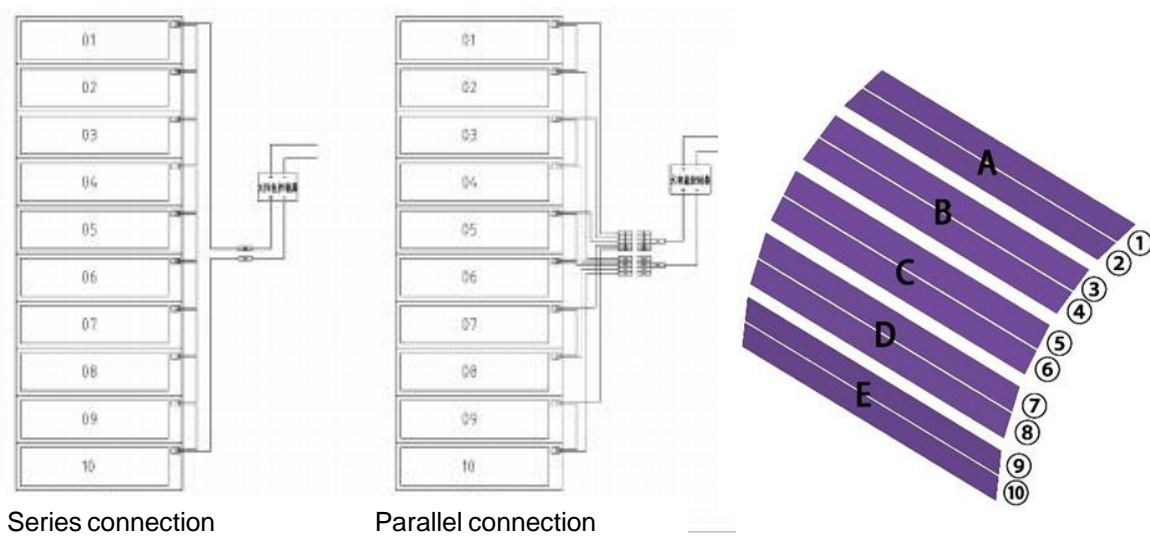

Fig.4.37 Schematic diagram of photovoltaic series and parallel mode

Source: APSEC

Technical Review on Emergency Shelters in APEC Region

According to the test results from September 8, the sun rose at around 5:30, the flexible thin film PV began to produce electricity, the morning was clear, and the PV power generation increased with the sun's irradiance; at around 13:00 and 14:00, however, there was a slight fluctuation because of cloud cover shading, and at around 15:00 there was an increase in clouds and a longer period of shading, which resulted in a significant drop in the PV power generation efficiency. According to calculations, PV generates roughly 0.81kWh of electricity per day. If the afternoon cloud cover were excluded, the theoretical power generation would be higher than the detection data.

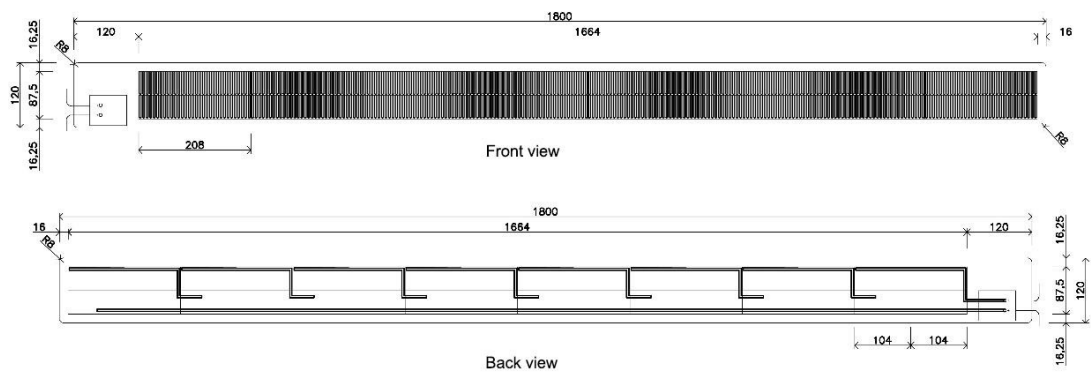

Fig.4.38 Dimensional drawing of flexible thin film photovoltaic

Source: APSEC



Fig.4.39 Process diagram of photovoltaic series and parallel experiment

Source: APSEC

In the test on September 9, every two PV modules with the same tilt angle were combined into one group, divided into five groups for the experiment, and tested the PV power generation power of ten modules connected in series and five groups of modules connected in parallel, the test time was from 9:00 to 15:00, every hour, and finally, by comparing the results of different moments, it can be seen that: in the morning and afternoon when the solar irradiance is low, the PV power generation power of series-parallel connection is significantly greater than that of series connection, and the greatest increase in the test was at 9:00, reaching 18.2%; while around noon when the solar irradiance is high, the difference between the PV power generated by series and the parallel connection is reduced, but still, the parallel connection is greater than the series connection, and the minimum increase after changing the method is 11:00, increasing by 1.5%. The reason for this result is that the solar irradiance in the morning and evening is low, and the resistance of PV increases with the reduction of light intensity, resulting in a larger resistance of flexible thin film PV by irradiance, the resistance change of one module in series connection will have a greater impact on the overall power generation, and the impact under parallel connection is much smaller than the series connection.

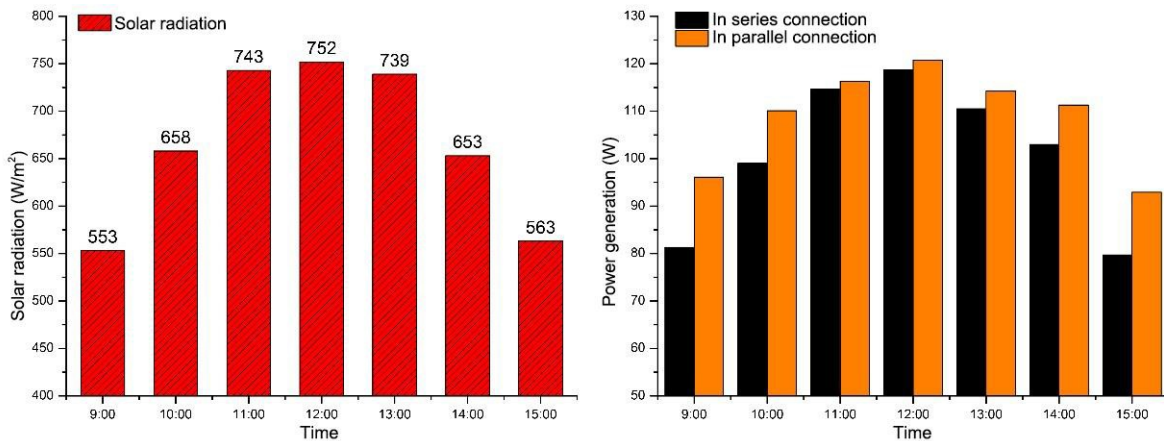

Fig.4.40 Comparison diagram of solar irradiance and series and parallel power

Source: APSEC

This conclusion can also be learned from the I-V curve test results of the two connection methods. Taking the 12:00 solar radiation as an example, due to the different radiance of the flexible thin-film PV on the unfolded surface, the series connection method has an unsmooth curve due to the large influence between the modules, while the parallel connection method has less influence, so the I-V curve is smoother.

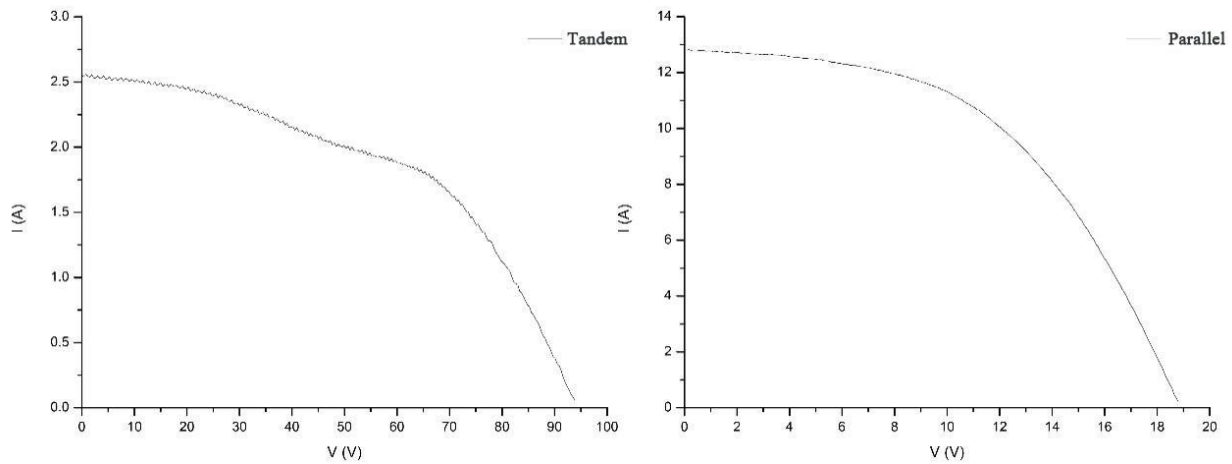

Fig.4.41 Series and parallel I-V curve test diagram

Source: APSEC

The experimental test of photovoltaic conversion efficiency, also with the more stable solar radiation at 12:00, for example, the five groups of photovoltaic modules were disassembled for separate testing while detecting the temperature of each group of module panels and back sheets, according to the official material data provided by Hanergy shows that the photovoltaic conversion efficiency of its flexible thin-film photovoltaic modules is 15%. While the actual test results show that, although the photovoltaic power generation is also greater with the enhancement of solar radiation, the photoelectric conversion efficiency is affected by the temperature, plus the energy loss on the wire, the actual measured maximum is 10.7%.

The energy end of the building is relatively simple, in addition to the fan used for indoor ventilation, in the rescue situation necessary for lighting lamps at night, the fan in the best ventilation rate is 28.58W, assuming that in hotter climates for the whole day operation, then the power consumed a day is 0.69kWh, in addition to two 8W energy-saving lamps for night lighting, open time is about 6h, then the power consumption of a day is 0.096kWh, a total of 0.786kWh, according to the climate conditions of September 8 the power generation is 0.811kWh, the remaining 0.025kWh, to meet the demand of energy self-sufficiency.

4.3 Available External Devices

In extreme weather, when the photovoltaic system can not ensure a regular supply of electricity and the indoor thermal environment can not meet the normal life of people needs to use an external energy system. The external energy system needs to meet mobility and can supply energy safely and stably.

The MNY120 clean and efficient intelligent energy station produced by Shanghai Fei Ao Gas

Equipment Co., Ltd. adopts a mobile skid-mounted module design, which integrates various renewable and clean energy sources such as photovoltaic, natural gas cooling, heating and power triple-supply, energy storage, etc., constituting a highly efficient and diversified energy supply system, which is simple and convenient, and can be transported and arranged in the nearest energy demand points (such as temporary buildings like shelters, parks that need their own energy emergency systems, outdoor operations, outdoor parties, etc.).



Fig.4.42 Example diagram of energy station

Source: APSEC

Micro solar photovoltaic systems and energy storage systems are used to build the first guarantee for an emergency: before the gas source is connected, the power supply for the important core load at the energy demand point is guaranteed; after the gas source is connected, the power supply for the whole system start-up is ensured.

Adopt natural gas cooling, heating and power triple-supply system to construct the second guarantee for an emergency: in the absence of a grid power supply, it can rely on a self-sufficient photovoltaic starter system to start the whole module and cooperate with a gas network or LNG tanker to provide safe, stable, efficient and clean energy for energy demand points, including stable and controllable electricity and air-conditioning cooling (heat), to supplement the energy demand points at night and in climatic conditions of long-term light shortage Energy supply to ensure the reliability of power supply and indoor environmental comfort. Comprehensive primary energy utilization efficiency is up to 88%.

The intelligent energy monitoring system ensures that the MNY120 clean and efficient smart energy station can operate efficiently and automatically based on the energy source, load and storage conditions.

Chapter 5 Conclusion

The design of a solar emergency building has a clear application scenario, and the focus is not only to meet the "emergency" requirements of ease of understanding, ease of operation and efficiency but also to ensure the integrated modular design of the solar system. At the same time, it is closely related to the climatic conditions and envelope construction of the affected area, taking into account the health of the habitat. The purpose of this report is to provide information on the potential applications and technologies related to SPESS within APEC. Specifically, this report provides.

- Understand user needs within the APEC disaster management framework (understand the needs)
- A review of research advances in emergency disaster relief construction-related technologies (to understand the collection of construction-related technologies available)
- Theoretical framework related to SPESS design (understanding the theoretical basis)
- SPESS related technology products (for broader context)

This report first analyzes the types and occurrences of disasters in the APEC region and finds that the most frequent disasters are floods, storms, earthquakes, landslides and typhoons. The most frequent disasters occur in the United States, Japan, the Philippines, Indonesia and China. Subsequently, the latest technologies in various aspects of emergency relief buildings are analyzed, including architectural and structural design, optimization of canopy performance, and improvement of the physical environment of the interior space. Again, the design elements of solar emergency buildings are reviewed, including the integration of solar technologies, modular design, and internal comfort enhancement paths. Finally, relevant practical cases are analyzed.

The bulk of the report is an overview of the theory and available technologies related to SPESS. There are several conceptual shelter designs throughout the APEC economies that incorporate solar energy. This report recommends several other issues for consideration in subsequent studies by the SPESS project.

Technical Review on Emergency Shelters in APEC Region

- Strengthening humanitarian innovation
- Evaluate the performance of physical products
- Open up multi-scene application channels
- Embrace investments and partnerships

Renewable energy plays a valuable role in reducing emissions. Still, it can also play an essential role in combating looming climate change and more frequent disasters, playing an even more significant role. SPES projects can transform people's lives and livelihoods by providing shelter and energy to rebuild communities.